





## Table of Contents

<b>General Applications</b>	<b>2-4</b>		
 <b>North American</b>	<b>5</b>	 <b>British BS 88</b>	<b>79</b>
FWA 130V 1000-4000A	6-7	240V 6-900A	80-81
FWA 150V 70-1000A	8-9	690V 6-700A	82-83
FWX 250V 35-2500A	10-11	Accessories	84
FWH 500V 35-1600A	12-13	Time-Current & Peak Let-Through Curves	85-89
KAC 600V 1-1000A	14		
KBC 600V 35-800A	15	 <b>Ferrule</b>	<b>91</b>
FWP 700V 5-1200A	16-17	FWA 150V 5-60A	92
FWJ 1000V 35-2000A	18-19	FWX 250V 1-30A	93
Accessories	20	FWH 500V 0.25-30A	94-95
Time-Current & Peak Let-Through Curves	21-26	FWC 600V 6-32A	96
		FWP 660V/700V 1-100A	97-98
 <b>Square Body</b>	<b>27</b>	FWK 750V 5-60A	99
Applications	28-29	FWJ 1000V 20-30A	100
DIN 43 653	30-43	FWL/FWS 1250/1500/2000V 2-30A	101
DIN 43 620	44-49	Accessories	102
Flush End Contact	50-59	Time-Current & Peak Let-Through Curves	103-108
French Style	60-61		
US Style	62-67		
Accessories	68-69		
Time-Current & Peak Let-Through Curves	70-78		

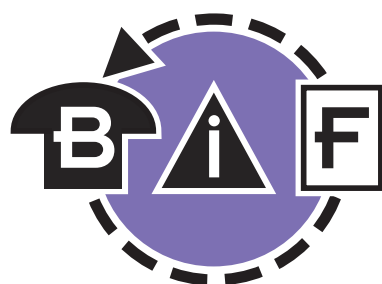

**Bussmann  
Information Fax ~  
636.527.1450**

**Get the latest, most up-to-date specification data on products listed in this catalog by calling Bussmann Information Fax.**

**BIF** is a simple to use automated fax response system. No need to wait for normal business hours; **BIF** is available around the clock for your convenience. All you need is a touch-tone telephone and a fax machine to get specification data when you want it.

A **BIF** document number is indicated with each product in this catalog. To get a detailed specification sheet simply call **636-527-1450** and follow the prompts. In a matter of minutes, a data sheet will be faxed to you. It's that simple!

**Bussmann Worldwide Web ~ <http://www.bussmann.com>**

# Bussmann®

## Worldwide Circuit Protection Solutions

North America's leading supplier of fuses and fusible protection systems, Bussmann® continues its 88-year history of blazing new trails of innovative technologies. Maker of the industry's first truly global product line, each item is backed by an efficient worldwide network of distribution, customer service and technical support. Bussmann® products include the most extensive circuit protection solutions that are built and tested to a variety of major standards and agency requirements such as: U.L., CSA, IEC, ISO. . . Additionally, both European (DIN, British Standard) and North American styled fuses are used for a wide range of applications: industrial motor protection,



power conversion, medium voltage power distribution, telecommunications network equipment, electronics, and automotive. Manufacturing operations in the U.S., Denmark, and the United Kingdom have earned ISO 9000 certification, assuring Bussmann customers only the utmost quality across every product line. Knowledgeable. Responsive. Customer focused. Bussmann® continues to set the standard for circuit



protection solutions in the global marketplace.

### Bussmann®—The Source For Global Solutions In Semiconductor Protection

Today's power electronics market knows no international boundaries – so neither should the high speed fuses that are used to protect semiconductor devices.

Only one fuse maker – Bussmann® – has the resources required to meet all of the power conversion industry's principle needs:

- Knowledgeable technical support
- Cutting-edge application design
- Global sourcing & manufacturing (certified to ISO 9000 standards)

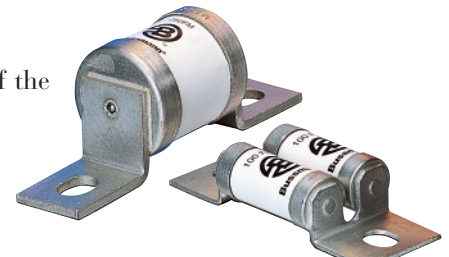

Bussmann® offers a comprehensive range of high speed fuselinks, specifically designed for semiconductor device protection. These products use advanced materials and technology to deliver unsurpassed performance.

All high speed fuses carry the quality assurance of the Bussmann® name – the recognized world leader in circuit protection.

This brochure summarizes the features and benefits of the following high speed fuses that Bussmann® manufactures for the power electronics market:



- North American
- British
- European (DIN)
- Ferrule

*This catalog is intended to present product data and provide technical information that will help the end user with design application. Bussmann® reserves the right, without notice, to change design or construction of any products and to discontinue or limit distribution of any products. Bussmann® also reserves the right to change or update, without notice, any technical information contained in this catalog. Once a product has been selected, it should be tested by the user in all possible applications.*

# General Applications

## Rated Voltage

The ac voltage rating of Bussmann fuses is given in volts RMS. Fuses tested to IEC are tested at 10% above their rated voltage. British Style BS 88 fuses are tested at 5% above its rated voltage. U.L. recognition tests are performed at the rated voltage.

## Rated Current

Rated current is given in amperes RMS. Bussmann fuses can continuously carry the rated current.

## Melting Characteristic

The melting characteristic shows the virtual melting time in seconds as a function of the prospective current in amperes RMS. The fuses are specially constructed for short-circuit protection against high level fault currents. Loading and operation of the fuse in the non-continuous/dashed section of the melt curve must be avoided. The curve can also be read as the real melting time as a function of the RMS value of the pre-arc current.

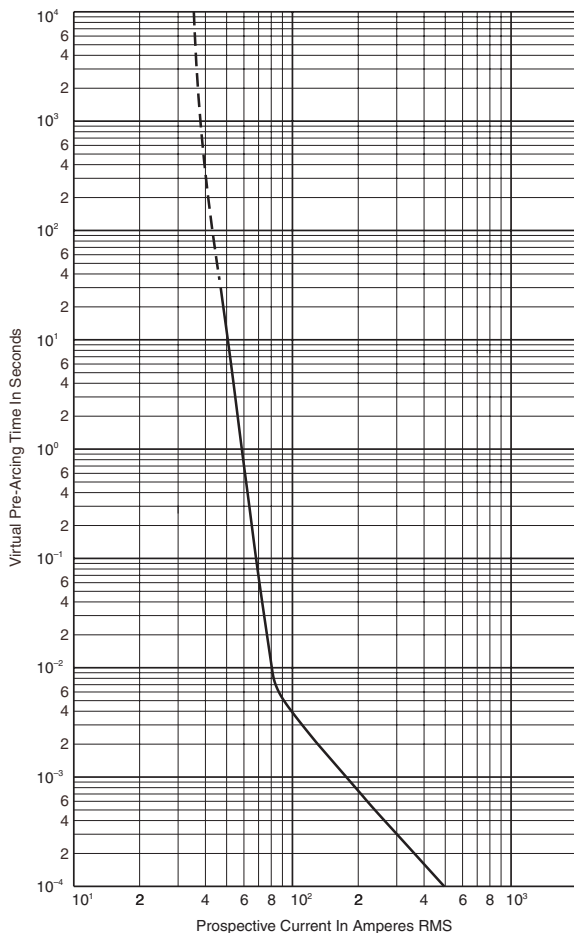

## Clearing Integrals

The total clearing  $I^2t$  at rated voltage and at power factor of 15% are given in the electrical characteristics. For other voltages, the clearing  $I^2t$  is found by multiplying by correction factor, K, given as a function of applied working voltage,  $E_g$ , (RMS).

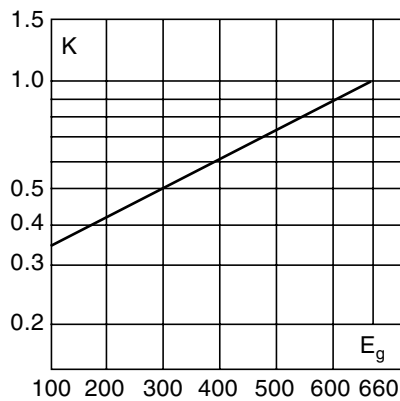

For other power factor values, the total clearing integral can be calculated as a multiple of the clearing integrals, the correction factor K and the correction factor X.

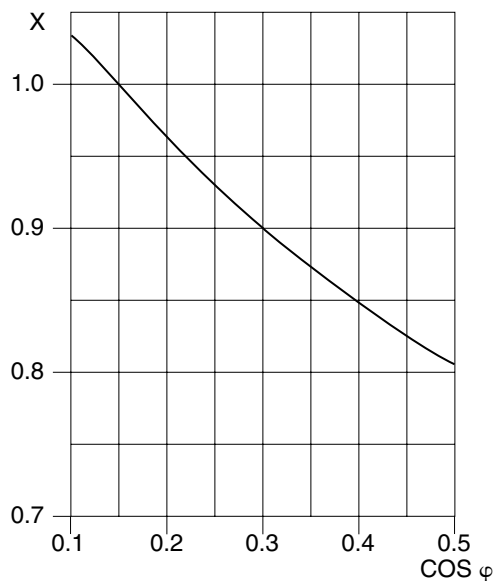

# General Applications

## Arc Voltage

This curve gives the peak arc voltage,  $U_L$ , which may appear across the fuse during its operation as a function of the applied working voltage,  $E_g$ , (RMS) at a power factor of 15%.

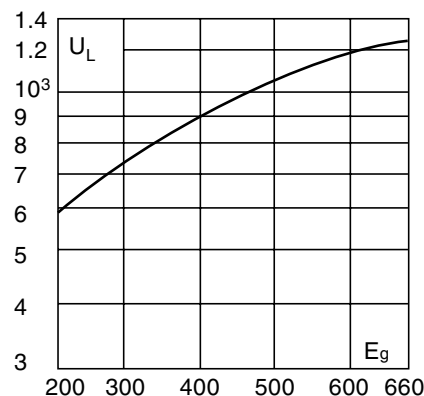

## Power Losses

Watts loss at rated current is given in the electrical characteristics. The curve allows the calculation of the power losses at load currents lower than the rated current. The correction factor,  $K_p$ , is given as a function of the RMS load current,  $I_b$ , in % of the rated current.

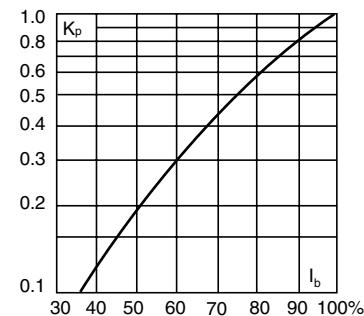

## Cut-Off Current

A fuse operation relating to short-circuits only. When a fuse operates in its current-limiting range, it will clear a short-circuit in less than  $\frac{1}{2}$  cycle. Also, it will limit the instantaneous peak let-through current to a value substantially less than that obtainable in the same circuit if that fuse were replaced with a solid conductor of equal impedance.

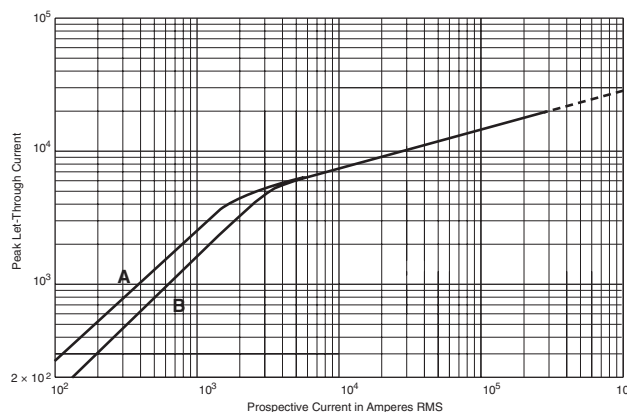

A asymmetrical current  
B symmetrical current

## Parallel Connection

When fuses are connected in parallel it is recommended that the applied voltage does not exceed  $0.9 U_N$  (the rated voltage of the fuse). This is due to the fact that the energy released within the fuses may be unevenly shared between the parallel connected barrels.

When fuses are connected in parallel, one must take into account that the current sharing is not necessarily equal. And it must be checked, that the maximum load current is not exceeded.

## Series Connection

Fuses in series may not equally divide the applied voltage. It is recommended that series connected fuses should only be operated at fault currents that yield melting times less than 10 ms and a recovery voltage per fuse of less than or equal to  $0.9 U_N$  (the rated voltage of the fuse).

## Mounting Guidance

The recommendations below have to be followed when mounting a Bussmann fuse with end plate threaded holes.

1. Screw in studs: Max. 5 N•m, Min. 3 N•m
2. Attachment of the fuse to buss-bar by means of nut and washer:

Thread Configuration	Max. Torque (N•m)	Min. Torque (N•m)
$\frac{5}{16}$ " - 18, M8	25	20
$\frac{3}{8}$ " - 16, M10	45	40
$\frac{3}{8}$ " - 24	45	40
$\frac{1}{2}$ " - 13, M12	65	50
$\frac{1}{2}$ " - 20	65	50

1 N•m = 0.7375 ft•lb



# General Applications

## Overloads

The design of Bussmann fuses is such that they can be operated under rather severe operating conditions imposed by overloads (any load current in excess of the maximum permissible load current).

In applications, there will be a maximum overload current,  $I_{max}$ , which can be imposed on the fuse with a corresponding duration and frequency of occurrence.

Time durations fall into two categories:

1. Overloads longer than one second
2. Overloads less than one second termed "impulse" loads.

The following table gives general application guidelines which, in the expression  $I_{max} < (\% \text{ factor}) \times I_t$ ,  $I_t$  is the melting current corresponding to the time "t" of the overload duration as read from the time-current curve of the fuse. The guidelines in the table below determine the acceptability of the selected fuses for a given  $I_{max}$ .

Frequency of Occurrence	Overloads (> 1 sec.)	Impulse Loads (< 1 sec.)
Less than one time per month	$I_{max} < 80\% \times I_t$	$I_{max} < 70\% \times I_t$
Less than twice per week	$I_{max} < 70\% \times I_t$	$I_{max} < 60\% \times I_t$
Several times per day	$I_{max} < 60\% \times I_t$	—

When impulse loads are an intrinsic/normal parameter of the load current either as single pulse or in trains of pulses or when their level is higher than the melting current at .01 seconds (per time-current curve), contact Bussmann for application assistance.

In addition to the parameters set forth in the preceding table, the rms value of the load current as calculated for any period of 10 minutes or more should not exceed the maximum permissible load current.

Furthermore, it is important that a fuse should not be applied in the non-continuous/dashed portion of the associated time-current curve.

Any time-current combination point which falls in the non-continuous/dashed portion of the time-current curve is beyond the capability of the fuse to operate properly.

## DC Operation

Depending upon the short-circuit time constant and the magnitude of the prospective short-circuit current, the dc voltage at which a fuse can be applied may be less than its ac rating. Long time constants require a lower dc voltage. Conversely, however, higher available prospective short-circuit currents result in faster fuse openings and thus permit a fuse to be operated at a higher dc voltage.

Consult Bussmann for additional information and application assistance when fuses have to operate under dc conditions.

## Load Current Versus Conductor Cross Section

Reduction of permissible load current when the conductor cross section is less than that given in IEC Publication 269-1 & 4 valid for Bussmann semiconductor fuses.

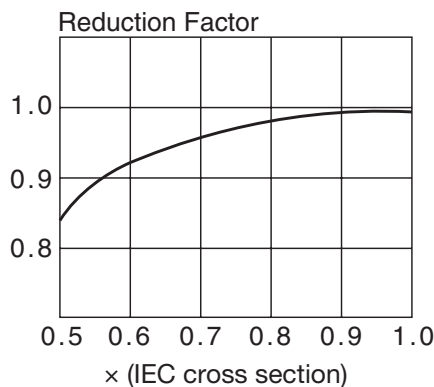





## Application Assistance

If you have application problems or need a fuse outside our standard program, please contact the nearest Bussmann representative. Phone numbers are shown on the inside back cover.



## Table of Contents

<b>General Applications</b>	<b>2-4</b>		
 <b>North American</b>	<b>5</b>	 <b>British BS 88</b>	<b>79</b>
FWA 130V 1000-4000A	6-7	240V 6-900A	80-81
FWA 150V 70-1000A	8-9	690V 6-700A	82-83
FWX 250V 35-2500A	10-11	Accessories	84
FWH 500V 35-1600A	12-13	Time-Current & Peak Let-Through Curves	85-89
KAC 600V 1-1000A	14		
KBC 600V 35-800A	15	 <b>Ferrule</b>	<b>91</b>
FWP 700V 5-1200A	16-17	FWA 150V 5-60A	92
FWJ 1000V 35-2000A	18-19	FWX 250V 1-30A	93
Accessories	20	FWH 500V 0.25-30A	94-95
Time-Current & Peak Let-Through Curves	21-26	FWC 600V 6-32A	96
		FWP 660V/700V 1-100A	97-98
 <b>Square Body</b>	<b>27</b>	FWK 750V 5-60A	99
Applications	28-29	FWJ 1000V 20-30A	100
DIN 43 653	30-43	FWL/FWS 1250/1500/2000V 2-30A	101
DIN 43 620	44-49	Accessories	102
Flush End Contact	50-59	Time-Current & Peak Let-Through Curves	103-108
French Style	60-61		
US Style	62-67		
Accessories	68-69		
Time-Current & Peak Let-Through Curves	70-78		

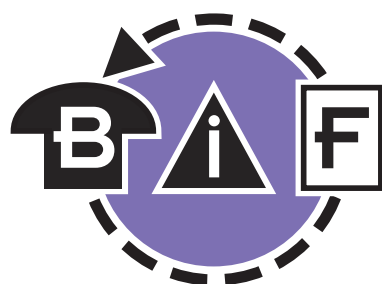

**Bussmann  
Information Fax ~  
636.527.1450**

**Get the latest, most up-to-date specification data on products listed in this catalog by calling Bussmann Information Fax.**

**BIF** is a simple to use automated fax response system. No need to wait for normal business hours; **BIF** is available around the clock for your convenience. All you need is a touch-tone telephone and a fax machine to get specification data when you want it.

A **BIF** document number is indicated with each product in this catalog. To get a detailed specification sheet simply call **636-527-1450** and follow the prompts. In a matter of minutes, a data sheet will be faxed to you. It's that simple!

**Bussmann Worldwide Web ~ <http://www.bussmann.com>**





# North American

## Introduction



### Table of Contents

Catalog Symbol	Ampere Range	Page
FWA 130V	1000-4000A	6-7
FWA 150V	70-1000A	8-9
FWX 250V	35-2500A	10-11
FWH 500V	35-1600A	12-13
KAC 600V	1-1000A	14
KBC 600V	35-800A	15
FWP 700V	5-1200A	16-17
FWJ 1000V	35-2000A	18-19
<b>Accessories</b>		
Fuse Bases		20
<b>Curves</b>		
Time-Current & Peak Let-Through		21-26

Voltage	AC	DC	Ampere Range
130	X	X	1000-4000
150	X	X	70-1000
250	X	X	35-2500
500	X	X	35-1600
600	X	—	1-1000
700	X	X	5-1200
800	—	X	40-600
1000	X	—	35-2000

### General Information

Bussmann offers a complete range of North American blade and flush-end style fuses and accessories. Their design and construction were optimized to provide:

- Low energy let-through (I<sup>2</sup>t)
- Low watts loss
- Superior cycling capability
- Low arc voltage
- Excellent DC performance

North American style fuses provide an excellent solution for medium power applications. While there are currently no published standards for these fuses, the industry has standardized on mounting centers that accept Bussmann fuses.

#### Voltage Rating

All Bussmann North American style fuses are tested at their rated voltage. Bussmann should be consulted for applications exceeding those values.

#### Accessories

External and internal open fuse indication is available for selected portions of the North American line. Fuseblocks are available for most applications.





# North American FWA 130V 1000-4000A



Type	Rated Current RMS-Amps	I <sup>2</sup> t (A <sup>2</sup> Sec)		Watts Loss	Ordering Information			Dimensions	Curves
		Pre-arc	Clearing at 130V		Part Number	Carton Qty.	Carton Weight (lbs)	Figure Number	See Page
FWA 130V	1000	170000	460000	60	FWA-1000AH	1	3.3	Fig. 1	page 21
	1200	270000	730000	70	FWA-1200AH				
	1500	520000	1400000	78	FWA-1500AH				
	2000	860000	2400000	108	FWA-2000AH				
	2500	1500000	4100000	130	FWA-2500AH				
	3000	2100000	5700000	150	FWA-3000AH				
	4000	3400000	9200000	257	FWA-4000AH			Fig. 2	

- Interrupting rating 200kA RMS Symmetrical.
- Watts loss provided at rated current.
- (130 Vdc/Interrupting Rating 50kA) U.L. Recognition on 1000 through 2000 amperes.
- See accessories on page 20.

1 kg = 2.2 lbs 1 lb = 0.45 kg

## Electrical Characteristics

### Total Clearing I<sup>2</sup>t

The total clearing I<sup>2</sup>t at rated voltage and at power factor of 15% are given in the electrical characteristics. For other voltages, the clearing I<sup>2</sup>t is found by multiplying by correction factor, K, given as a function of applied working voltage, E<sub>g</sub>, (RMS).

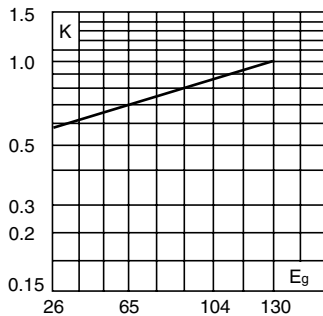

### Arc Voltage

This curve gives the peak arc voltage, U<sub>L</sub>, which may appear across the fuse during its operation as a function of the applied working voltage, E<sub>g</sub>, (RMS) at a power factor of 15%.

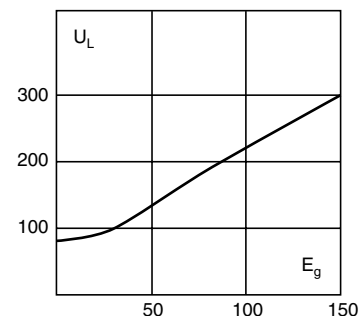

### Power Losses

Watts loss at rated current is given in the electrical characteristics. The curve allows the calculation of the power losses at load currents lower than the rated current. The correction factor, K<sub>p</sub>, is given as a function of the RMS load current, I<sub>b</sub>, in % of the rated current.

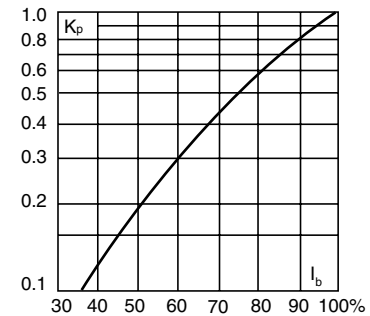





**North American**  
**FWA 130V 1000-4000A**



**Dimensions**

Fig. 1: 1000-3000 Amp Range

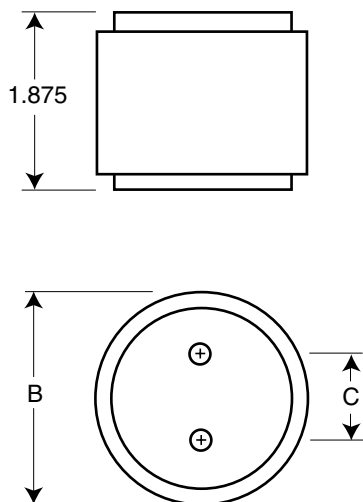
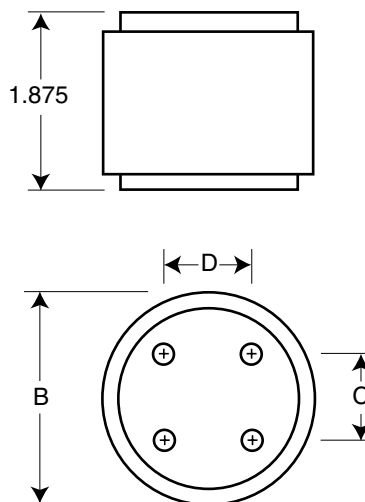

Fig. 2: 4000 Amp Range



Order #	Fig.	B	C	D	Thread Depth
FWA-1000AH-2000AH	1	2.0	1.0	—	Tapped $\frac{3}{8}$ "-24 x $\frac{1}{2}$ "
FWA-2500AH-3000AH	1	3.0	1.5	—	Tapped $\frac{1}{2}$ "-20 x $\frac{1}{2}$ "
FWA-4000AH	2	3.5	1.5	1.5	Tapped $\frac{1}{2}$ "-20 x $\frac{1}{2}$ "

Dimension in inches.  
 1mm = 0.0394" 1" = 25.4mm





# North American FWA 150V 70-1000A



Type	Rated Current RMS-Amps	Electrical Characteristics		Watts Loss	Ordering Information		Dimensions	Curves	
		I <sup>2</sup> t (A <sup>2</sup> Sec)			Part Number	Carton Qty.			Carton Weight (lbs)
		Pre-arc	Clearing at 150V					See Page	
FWA 150V	70	470	4000	6.9	FWA-70B	1	1.76	Fig. 1	page 21
	80	670	6000	7.7	FWA-80B				
	100	1200	12000	9.0	FWA-100B				
	125	1870	18000	11.2	FWA-125B				
	150	2700	26000	13.5	FWA-150B				
	200	4780	45000	17.6	FWA-200B				
	250	7470	70000	22.5	FWA-250B				
	300	10760	100000	27.0	FWA-300B				
	350	15700	140000	30.6	FWA-350B				
	400	20300	180000	35.2	FWA-400B				
	500	39000	120000	35.0	FWA-500A	5	2.42	Fig. 2	
	600	46000	140000	47.0	FWA-600A				
	700	75000	220000	49.0	FWA-700A				
	800	92000	280000	58.0	FWA-800A				
	1000	170000	510000	60.0	FWA-1000A				

- Interrupting rating 100kA RMS Symmetrical for ampere ratings 70-400.
- Interrupting rating 200kA RMS Symmetrical for ampere ratings 450-1000.
- Watts loss provided at rated current.
- (150 Vdc/Interrupting rating 20kA) U.L. Recognition on 70- 800 amperes.
- (80 Vdc/Interrupting rating 100kA) U.L. Recognition on 70-400 amperes.
- See accessories on page 20.

1 kg = 2.2 lbs 1 lb = 0.45 kg

## Electrical Characteristics

### Total Clearing I<sup>2</sup>t

The total clearing I<sup>2</sup>t at rated voltage and at power factor of 15% are given in the electrical characteristics. For other voltages, the clearing I<sup>2</sup>t is found by multiplying by correction factor, K, given as a function of applied working voltage, E<sub>g</sub>, (RMS).

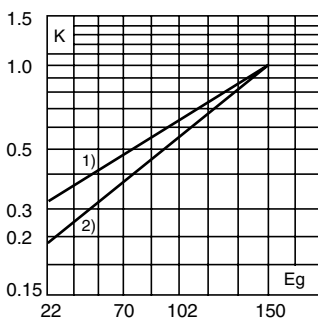

1) 500-1000 Amp Range  
2) 70-400 Amp Range

### Arc Voltage

This curve gives the peak arc voltage, U<sub>L</sub>, which may appear across the fuse during its operation as a function of the applied working voltage, E<sub>g</sub>, (RMS) at a power factor of 15%.

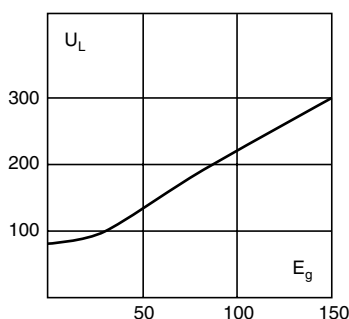

### Power Losses

Watts loss at rated current is given in the electrical characteristics. The curve allows the calculation of the power losses at load currents lower than the rated current. The correction factor, K<sub>p</sub>, is given as a function of the RMS load current, I<sub>b</sub>, in % of the rated current.

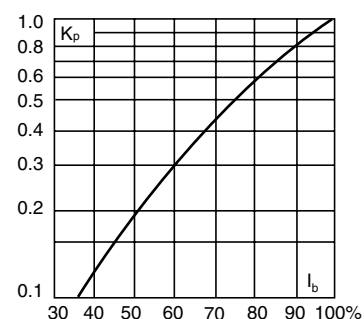



**North American  
FWA 150V 70-1000A**

**Dimensions**

Fig. 1: 70-400 Amp Range

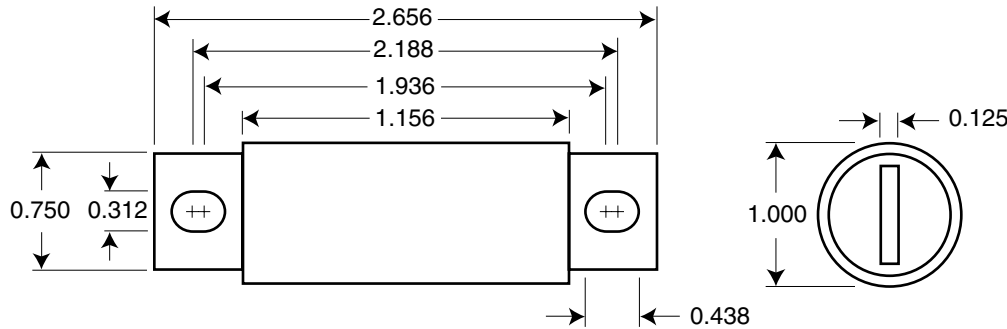
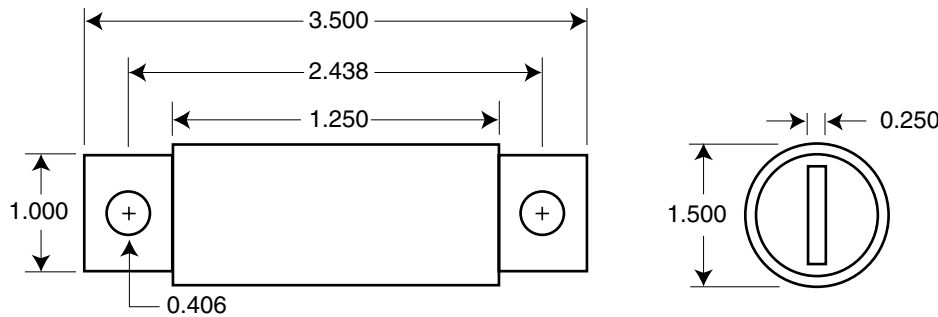

Fig. 2: 500-1000 Amp Range



Dimension in inches.  
1mm = 0.0394" 1" = 25.4mm





# North American FWX 250V 35-2500A



Type	Electrical Characteristics				Ordering Information			Dimensions	Curves		
	Rated Current RMS-Amps	I <sup>2</sup> t (A <sup>2</sup> Sec)		Watts Loss	Part Number	Carton Qty.	Carton Weight (lbs)	Figure Number	See Page		
Pre-arc		Clearing at 250V									
FWX 250V	35	50	230	4.2	FWX-35A	5	1.40	Fig. 1	page 22		
	40	60	310	5.2	FWX-40A						
	45	80	390	5.7	FWX-45A						
	50	100	520	6.0	FWX-50A						
	60	140	740	8.1	FWX-60A						
	70	330	1400	7.2	FWX-70A	1	0.32				
	80	430	1850	8.1	FWX-80A						
	90	570	2450	9.0	FWX-90A						
	100	740	3150	10.0	FWX-100A						
	125	1130	4850	12.5	FWX-125A						
	150	1620	6950	15.7	FWX-150A						
	175	2170	9300	18.5	FWX-175A						
	200	2790	12000	22	FWX-200A						
	225	3210	14700	24	FWX-225A						
	250	3960	18100	27	FWX-250A						
	275	4720	21600	31	FWX-275A						
	300	6000	27300	32	FWX-300A					1	0.52
	350	10600	48600	39	FWX-350A						
	400	14500	66100	44	FWX-400A						
	450	22100	101000	49	FWX-450A						
	500	28000	128000	54	FWX-500A						
	600	41100	188000	62	FWX-600A						
	700	48800	190000	72	FWX-700A						
	800	59000	230000	84	FWX-800A	1	0.90				
	1000	44000	360000	100	FWX-1000AH						
1200	92000	750000	103	FWX-1200AH							
1500	120000	880000	140	FWX-1500AH							
1600	160000	1200000	140	FWX-1600AH							
2000	320000	2300000	151	FWX-2000AH	1	2.86					
2500	670000	4700000	163	FWX-2500AH							

† U.L. Recognition on 35 through 800 amperes only.

1 kg = 2.2 lbs 1 lb = 0.45 kg

- Interrupting rating 200kA RMS Symmetrical.
- Watts loss provided at rated current.
- (250 Vdc/Interrupting rating 20kA) U.L. Recognition on 35 through 800 amperes only.
- See accessories on page 20.





# North American FWX 250V 35-2500A



## Electrical Characteristics

### Total Clearing I<sup>2</sup>t

The total clearing I<sup>2</sup>t at rated voltage and at power factor of 15% are given in the electrical characteristics. For other voltages, the clearing I<sup>2</sup>t is found by multiplying by correction factor, K, given as a function of applied working voltage, E<sub>g</sub>, (RMS).

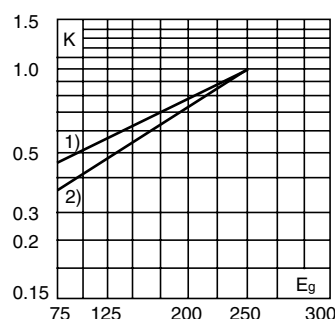

1) 35-800 Amp Range  
2) 1000-2500 Amp Range

### Arc Voltage

This curve gives the peak arc voltage, U<sub>L</sub>, which may appear across the fuse during its operation as a function of the applied working voltage, E<sub>g</sub>, (RMS) at a power factor of 15%.

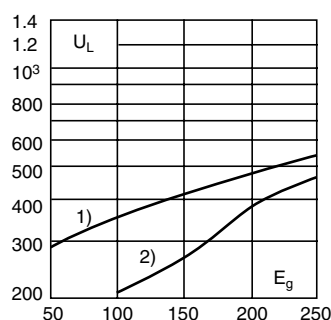

1) 35-800 Amp Range  
2) 1000-2500 Amp Range

### Power Losses

Watts loss at rated current is given in the electrical characteristics. The curve allows the calculation of the power losses at load currents lower than the rated current. The correction factor, K<sub>p</sub>, is given as a function of the RMS load current, I<sub>b</sub>, in % of the rated current.

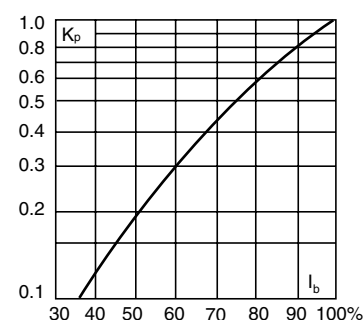

## Dimensions

Fig. 1: 35-800 Amp Range

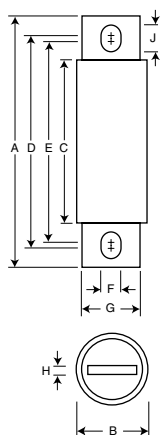

Fig. 2: 1000-1200 Amp Range

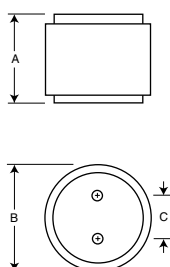
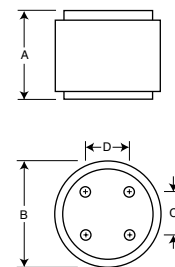

Fig. 3: 1500-2500 Amp Range



Order #	Fig.	A	B	C	D	E	F	G	H	J	Thread Depth
FWX-35A-60A	1	3.19	0.81	1.59	2.59	2.25	0.34	0.63	0.13	0.52	—
FWX-70A-200A	1	3.13	1.22	1.59	2.44	2.19	0.34	1.00	0.19	0.47	—
FWX-225A-600A	1	3.84	1.50	1.59	2.94	2.25	0.41	1.00	0.25	0.75	—
FWX-700A-800A	1	3.84	2.00	1.59	3.03	2.28	0.41	1.50	0.25	0.78	—
FWX-1000AH-1200AH	2	2.59	3.00	1.50	—	—	—	—	—	—	Tapped 3/8"-24 x 1/2"
FWX-1500AH-2500AH	3	2.59	3.50	1.50	1.50	—	—	—	—	—	Tapped 3/8"-24 x 1/2"

Dimension in inches.  
1mm = 0.0394" 1" = 25.4mm





# North American FWH 500V 35-1600A



Type	Electrical Characteristics				Ordering Information			Dimensions	Curves	
	Rated Current RMS-Amps	I <sup>2</sup> t (A <sup>2</sup> Sec)		Watts Loss	Part Number	Carton Qty.	Carton Weight (lbs)	Figure Number	See Page	
Pre-arc		Clearing at 500V								
FWH 500V	35	34	150	8	FWH-35B	5	0.71	Fig. 1	page 23	
	40	76	320	7.5	FWH-40B					
	45	105	450	7.5	FWH-45B					
	50	135	670	7.5	FWH-50B					
	60	210	900	9.9	FWH-60B					
	70	210	900	10.6	FWH-70B					
	80	305	1400	12.7	FWH-80B	1	0.21			
	90	360	1600	15	FWH-90B					
	100	475	2000	17	FWH-100B					
	125	800	3500	25	FWH-125B		0.33			
	150	1100	4600	30	FWH-150B					
	175	1450	6200	35	FWH-175B		0.57			
	200	1900	8500	40	FWH-200B					
	225	4600	23300	39	FWH-225A					
	250	6300	32200	41	FWH-250A					
	275	7900	40300	46	FWH-275A					
	300	9800	49800	51	FWH-300A					
	325	13700	63800	53	FWH-325A	1.00				
	350	14500	72900	58	FWH-350A					
	400	19200	96700	65	FWH-400A	2.14				
450	24700	127000	74	FWH-450A						
500	29200	149000	84	FWH-500A	4.62					
600	41300	206000	108	FWH-600A						
700	55000	298000	120	FWH-700A	11.66					
800	76200	409000	129	FWH-800A						
1000	92000	450000	145	FWH-1000A	Fig. 2					
1200	122000	600000	180	FWH-1200A						
1400	200000	1000000	210	FWH-1400A						
1600	290000	1400000	230	FWH-1600A						

†U.L. Recognition on 35 through 1200 amperes only.  
CSA Component Acceptance: 35 - 1600A.

1 kg = 2.2 lbs 1 lb = 0.45 kg

- Interrupting rating 200kA RMS Symmetrical.
- Watts loss provided at rated current.
- (500 Vdc/Interrupting rating 50kA) U.L. Recognition on 35 through 800 amperes only.
- See accessories on page 20.







# North American FWH 500V 35-1600A



## Electrical Characteristics

### Total Clearing I<sup>2</sup>t

The total clearing I<sup>2</sup>t at rated voltage and at power factor of 15% are given in the electrical characteristics. For other voltages, the clearing I<sup>2</sup>t is found by multiplying by correction factor, K, given as a function of applied working voltage, E<sub>g</sub>, (RMS).

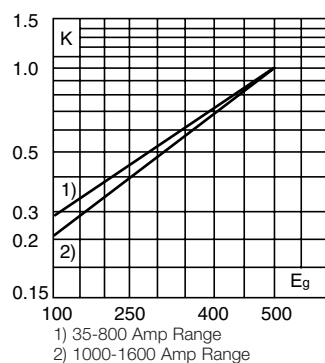

### Arc Voltage

This curve gives the peak arc voltage, U<sub>L</sub>, which may appear across the fuse during its operation as a function of the applied working voltage, E<sub>g</sub>, (RMS) at a power factor of 15%.

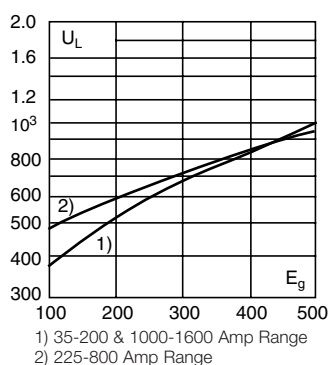

### Power Losses

Watts loss at rated current is given in the electrical characteristics. The curve allows the calculation of the power losses at load currents lower than the rated current. The correction factor, K<sub>p</sub>, is given as a function of the RMS load current, I<sub>b</sub>, in % of the rated current.

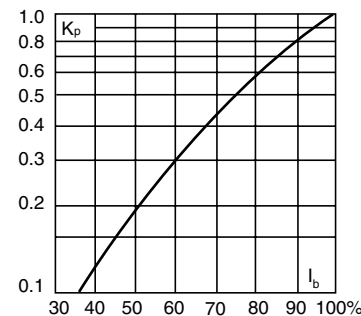

## Dimensions

Fig. 1: 35-1200 Amp Range

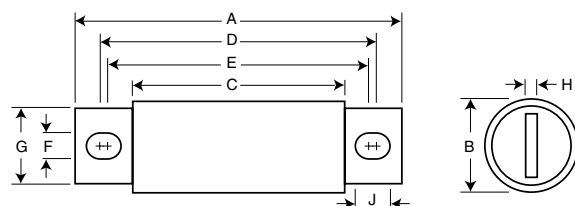
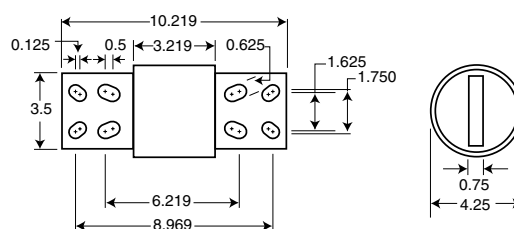

Fig. 2: 1400-1600 Amp Range



Order #	Fig.	A	B	C	D	E	F	G	H	J
FWH-35B-60B	1	3.188	0.813	1.593	2.541	2.193	0.344	0.719	0.125	0.518
FWH-70B-100B	1	3.625	0.947	1.736	2.853	2.807	0.352	0.750	0.125	0.375
FWH-125B-200B	1	3.625	1.156	1.836	2.892	2.768	0.344	1.000	0.188	0.406
FWH-225A-400A	1	4.340	1.500	2.090	3.440	2.750	0.410	1.000	0.250	0.750
FWH-450A-600A	1	4.340	2.000	2.090	3.530	2.780	0.410	1.500	0.250	0.780
FWH-700A-800A	1	6.340	2.500	2.090	4.970	3.440	0.530	2.000	0.380	1.300
FWH-1000A-1200A	1	6.969	3.000	3.219	5.465	4.475	0.625	2.375	0.438	1.120
FWH-1400A-1600A	2	See Drawing								

Dimension in inches.  
1mm = 0.0394" 1" = 25.4mm





# North American KAC 600V 1-1000A



For new installations, Bussmann recommends the 700 volt FWP series fuse. The 600V fuses are supplied as replacements only.

Type	Ordering Information			Carton Qty.	Carton Weight (lbs)	Dimensions Figure Number
	Part Number					
KAC 600V	KAC-1	KAC-7	KAC-17.5	10	0.50	Fig. 1
	KAC-2	KAC-8	KAC-20			
	KAC-3	KAC-9	KAC-25			
	KAC-4	KAC-10	KAC-30			
	KAC-5	KAC-12				
	KAC-6	KAC-15				
	KAC-35	KAC-45	KAC-60	5	1.56	Fig. 2
	KAC-40	KAC-50				
	KAC-70	KAC-90		1	0.78	Fig. 1
	KAC-80	KAC-100				
KAC-110	KAC-150	KAC-200				
KAC-125	KAC-175					
KAC-225	KAC-300	KAC-400	1	1.92	Fig. 1	
KAC-250	KAC-350					
KAC-450	KAC-600	KAC-800	1	3.16	Fig. 1	
KAC-500	KAC-700					
KAC-1000			1	6.24		

†U.L. Recognition on 1 through 600 amperes only. 1 kg = 2.2 lbs 1 lb = 0.45 kg  
 ■ Interrupting rating 200kA RMS Symmetrical.  
 ■ Consult Bussmann for DC ratings.  
 ■ See accessories on page 20.

## Dimensions

Fig. 1: 1-30 & 450-1000 Amp Range

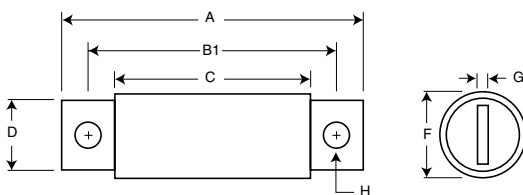
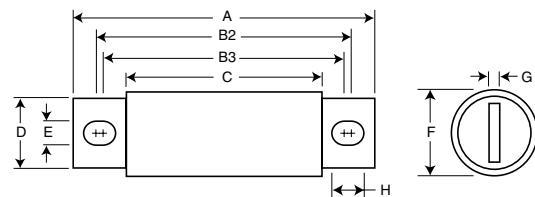

Fig. 2: 35-400 Amp Range



Order #	Fig.	A	B1	B2	B3	C	D	E	F	G	H
KAC-1-30	1	2.875	2.500	—	—	1.875	0.406	—	0.563	0.063	0.257
KAC-35-60	2	4.375	—	3.750	3.500	2.750	0.625	0.343	0.813	0.094	0.468
KAC-70-100	2	5.000	—	4.063	3.656	2.750	0.750	0.406	1.000	0.125	0.609
KAC-110-200	2	5.140	—	4.390	3.766	2.906	1.000	0.406	1.500	0.188	0.718
KAC-225-400	2	6.182	—	4.815	4.565	3.000	1.625	0.562	2.000	0.250	0.687
KAC-450-800	1	6.250	4.750	—	—	3.063	2.000	—	2.500	0.250	0.563
KAC-1000	1	7.250	4.750	—	—	3.063	2.750	—	3.500	0.375	0.563

Dimension in inches.  
 1mm = 0.0394" 1" = 25.4mm





# North American KBC 600V 35-800A



For new installations, Bussmann recommends the 700 Volt FWP series fuse. The 600V fuses are supplied as replacements only.

Type	Ordering Information			Dimensions	
	Part Number	Carton Qty.	Carton Weight (lbs)	Figure Number	
KBC 600V	KBC-35 KBC-45 KBC-60 KBC-40 KBC-50	10	1.40	Fig. 1	
	KBC-70 KBC-90 KBC-80 KBC-100	5	1.44	Fig. 2	
	KBC-110 KBC-150 KBC-200 KBC-125 KBC-175	1	0.48	Fig. 1	
	KBC-225 KBC-300 KBC-400 KBC-250 KBC-350		0.77		
	KBC-450 KBC-500 KBC-600		1.32		
	KBC-800		4.50		

†U.L. Recognition on 35 through 600 amperes only. 1 kg = 2.2 lbs 1 lb = 0.45 kg

- Interrupting rating 200kA RMS Symmetrical.
- Consult Bussmann for DC ratings.
- See accessories on page 20.

## Dimensions

Fig. 1: 35-60 and 110-600 Amp Range

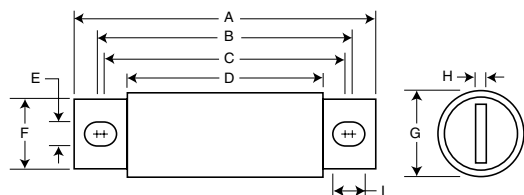

Fig. 2: 70-100 Amp Range

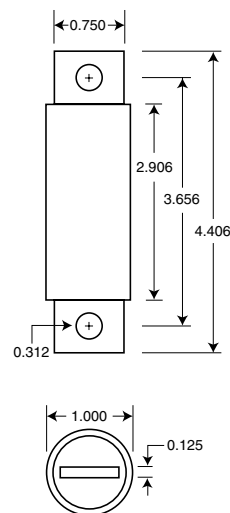
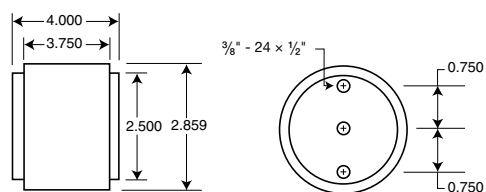

Fig. 3: 800 Amp Range



Order #	Fig.	A	B	C	D	E	F	G	H	I
KBC-35-60	1	4.375	3.750	3.500	2.750	0.343	0.625	0.813	0.094	0.468
KBC-70-100	2	See Drawing								
KBC-110-200	1	4.406	3.719	3.594	2.906	0.312	0.875	1.219	0.187	0.375
KBC-225-400	1	5.125	4.188	3.563	2.906	0.406	1.000	1.500	0.250	0.719
KBC-450-600	1	5.125	4.389	3.687	2.875	0.406	1.500	2.000	0.250	0.757
KBC-800	3	See Drawing								

Dimension in inches.  
1mm = 0.0394" 1" = 25.4mm





# North American FWP 700V 5-1200A



Type	Electrical Characteristics				Ordering Information			Dimensions	Curves
	Rated Current RMS-Amps	I <sup>2</sup> t (A <sup>2</sup> Sec)		Watts Loss	Part Number	Carton Qty.	Carton Weight (lbs)	Figure Number	See Page or (BIF #)
Pre-arc		Clearing at 700V							
FWP 700V	5	1.6	10	1.5	FWP-5B	10	2.25	Fig. 1	page 24 (35785316)
	10	3.6	20	4	FWP-10B				
	15	10	75	5.5	FWP-15B				
	20	26	180	6	FWP-20B				
	25	44	340	7	FWP-25B				
	30	58	450	9	FWP-30B				
	35	34	160	12	FWP-35B	5	1.21	Fig. 1	page 24 (35785308)
	40	76	320	12	FWP-40B				
	50	135	600	12	FWP-50B				
	60	210	950	15.5	FWP-60B				
	70	305	2000	18	FWP-70B				
	80	360	2400	21	FWP-80B				
	90	415	2700	25	FWP-90B	1	0.24	Fig. 1	page 25 (361)
	100	540	3500	27	FWP-100B				
	125	1800	7300	28	FWP-125A				
	150	2900	11700	32	FWP-150A				
	175	4200	16700	35	FWP-175A		0.65		
	200	5500	22000	43	FWP-200A				
	225	7700	31300	45	FWP-225A				
	250	10500	42500	48	FWP-250A				
	300	17600	71200	58	FWP-300A		1.17		
	350	23700	95600	65	FWP-350A				
	400	31000	125000	78	FWP-400A				
	450	36400	137000	94	FWP-450A				
500	45200	170000	107	FWP-500A	2.39				
600	66700	250000	122	FWP-600A					
700	54000	300000	125	FWP-700A					
800	78000	450000	140	FWP-800A					
900	91500	530000	150	FWP-900A	1.21				
1000	120000	600000	170	FWP-1000A					
1200	195000	1100000	190	FWP-1200A					
						6.60	Fig. 2	page 24 (35785308)	
						Fig. 3			

- Interrupting rating 200kA RMS Symmetrical.
- Watts loss provided at rated current.
- ( 700 Vdc/Interrupting rating 50kA) U.L. Recognition on 5 through 800 amperes only.
- CSA Component Acceptance: 35 - 100A & 700 - 1200A.
- See accessories on page 20.



1 kg = 2.2 lbs 1 lb = 0.45 kg





# North American FWP 700V 5-1200A



## Electrical Characteristics

### Total Clearing I<sup>2</sup>t

The total clearing I<sup>2</sup>t at rated voltage and at power factor of 15% are given in the electrical characteristics. For other voltages, the clearing I<sup>2</sup>t is found by multiplying by correction factor, K, given as a function of applied working voltage, E<sub>g</sub>, (RMS).

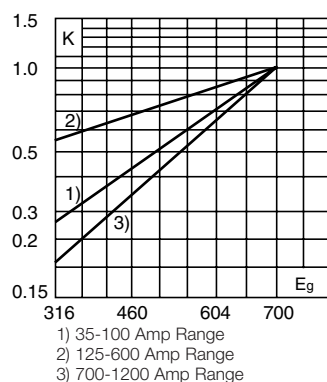

### Arc Voltage

This curve gives the peak arc voltage, U<sub>L</sub>, which may appear across the fuse during its operation as a function of the applied working voltage, E<sub>g</sub>, (RMS) at a power factor of 15%.

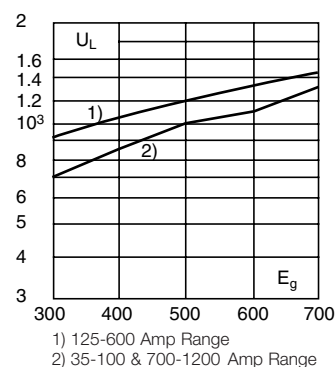

### Power Losses

Watts loss at rated current is given in the electrical characteristics. The curve allows the calculation of the power losses at load currents lower than the rated current. The correction factor, K<sub>p</sub>, is given as a function of the RMS load current, I<sub>b</sub>, in % of the rated current.

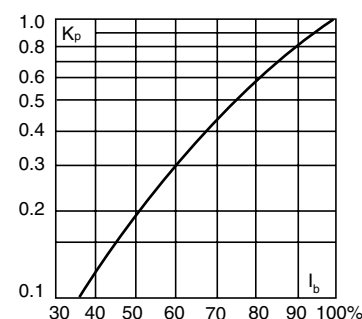

## Dimensions

Fig. 1: 5-800 Amp Range

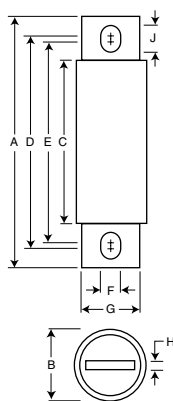

Fig. 2: 900-1000 Amp Range

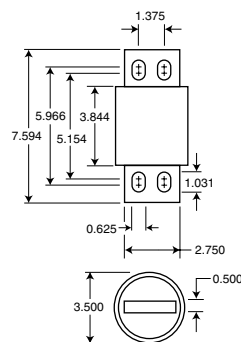
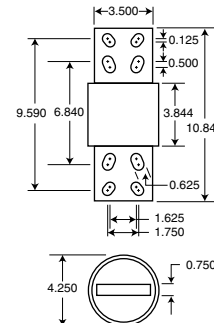

Fig. 3: 1200 Amp Range



Order #	Fig.	A	B	C	D	E	F	G	H	J
FWP-5B-30B	1	2.870	0.563	1.855	2.477	2.477	0.250	0.405	0.063	0.250
FWP-35B-60B	1	4.375	0.813	2.750	3.708	3.312	0.344	0.725	0.125	0.542
FWP-70B-100B	1	4.406	0.947	2.594	3.625	3.563	0.344	0.750	0.125	0.375
FWP-125A-200A	1	5.090	1.500	2.840	4.190	3.500	0.410	1.000	0.250	0.750
FWP-225A-400A	1	5.090	2.000	2.840	4.280	3.530	0.410	1.500	0.250	0.780
FWP-450A-600A	1	7.090	2.500	2.840	5.720	4.190	0.530	2.000	0.380	1.300
FWP-700A-800A	1	6.630	2.000	2.844	5.562	5.062	0.625	1.500	0.250	0.875
FWP-900A-1000A	2	See Drawing								
FWP-1200A	3	See Drawing								

Dimension in inches.  
1mm = 0.0394" 1" = 25.4mm





# North American FWJ 1000V 35-2000A



Type	Electrical Characteristics				Ordering Information		Dimensions	Curves		
	Rated Current RMS-Amps	I <sup>2</sup> t (A <sup>2</sup> Sec)		Watts Loss	Part Number	Carton Qty.	Carton Weight (lbs)	Figure Number	See Page or (BIF #)	
Pre-arc		Clearing at 1000V								
FWJ 1000V	35	210	2000	7	FWJ-35A	10	4.18	Fig. 1	page 25 (35785303)	
	40	300	2500	8	FWJ-40A					
	50	470	3500	10	FWJ-50A					
	60	670	5000	11	FWJ-60A					
	70	1100	6900	12	FWJ-70A					
	80	1550	9700	13	FWJ-80A					
	90	1900	12000	14	FWJ-90A					
	100	2800	17500	15	FWJ-100A					
	125	4800	35000	16	FWJ-125A	1	4.40			page 26 (35785309)
	150	6300	45000	25	FWJ-150A					
	175	7500	65000	30	FWJ-175A					
	200	11700	80000	32	FWJ-200A					
	250	16000	112000	50	FWJ-250A		4.84			
	300	23500	164000	56	FWJ-300A					
	350	33000	231000	62	FWJ-350A					
	400	47000	330000	67	FWJ-400A					
	500	39500	329000	95	FWJ-500A	5.28				
	600	61000	520000	105	FWJ-600A					
	800	87000	500000	182	FWJ-800A					
	1000	190000	1100000	206	FWJ-1000A					
	1200	370000	2100000	240	FWJ-1200A					
	1400	470000	2700000	248	FWJ-1400A					
	1600	700000	4000000	267	FWJ-1600A					
	1800	925000	5300000	239	FWJ-1800A					
	2000	1330000	7600000	244	FWJ-2000A					

†U.L. Recognition on 35 through 600 amperes only.

1 kg = 2.2 lbs 1 lb = 0.45 kg

- Interrupting rating 25kA for 35 through 200 amperes.
- Interrupting rating 100kA for 250 through 2000 amperes.
- Watts loss provided at rated current.
- (800 Vdc/Interrupting rating 50kA) U.L. Recognition on 35-200 and 450-600 amperes.
- See accessories on page 20.







# North American FWJ 1000V 35-2000A



## Electrical Characteristics

### Total Clearing I<sup>2</sup>t

The total clearing I<sup>2</sup>t at rated voltage and at power factor of 15% are given in the electrical characteristics. For other voltages, the clearing I<sup>2</sup>t is found by multiplying by correction factor, K, given as a function of applied working voltage, E<sub>g</sub>, (RMS).

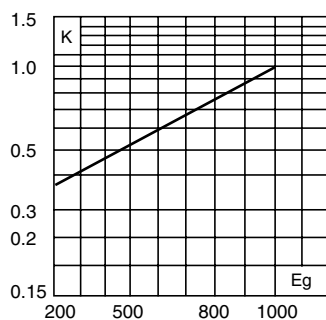

### Arc Voltage

This curve gives the peak arc voltage, U<sub>L</sub>, which may appear across the fuse during its operation as a function of the applied working voltage, E<sub>g</sub>, (RMS) at a power factor of 15%.

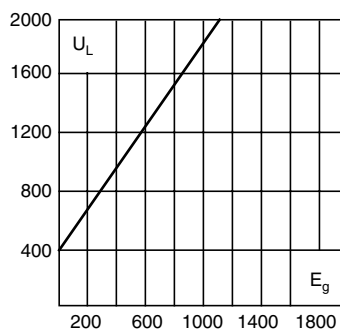

### Power Losses

Watts loss at rated current is given in the electrical characteristics. The curve allows the calculation of the power losses at load currents lower than the rated current. The correction factor, K<sub>p</sub>, is given as a function of the RMS load current, I<sub>b</sub>, in % of the rated current.

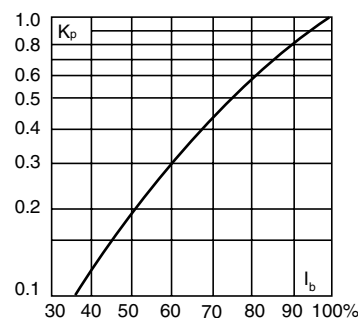

## Dimensions

Fig. 1: 35-2000 Amp Range

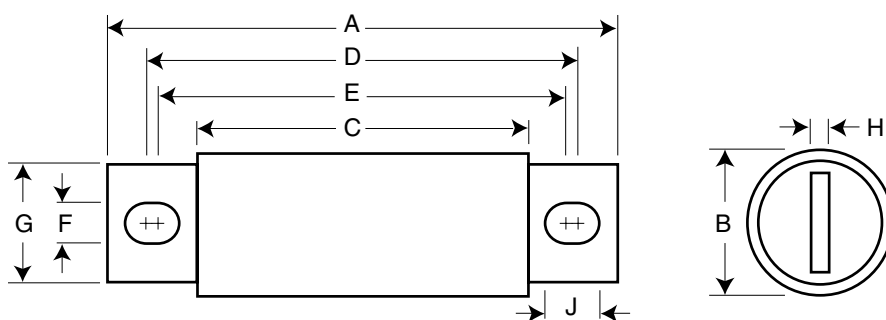

Order #	Fig.	A	B	C	D	E	F	G	H	J
FWJ-35A-60A	1	5.000	0.940	3.110	4.235	4.180	0.352	0.750	0.125	0.380
FWJ-70A-100A	1	4.932	1.125	3.085	4.266	4.156	0.352	1.000	0.188	0.407
FWJ-125A-200A	1	5.685	1.526	3.261	4.803	4.055	0.445	1.000	0.250	0.819
FWJ-250A-400A	1	5.768	2.000	3.500	4.811	4.150	0.433	1.500	0.250	0.764
FWJ-500A-600A	1	7.201	2.500	3.465	5.984	4.706	0.562	2.000	0.375	1.201
FWJ-800A-2000A	1	6.811	3.500	3.312	5.472	4.962	0.625	2.750	0.500	0.880

Dimension in inches.  
1mm = 0.0394" 1" = 25.4mm





## North American – Accessories

# Fuse Bases (Blocks)

### Modular Style

Bussmann offers a comprehensive line of fuse bases that provide the user with design and manufacturing flexibility. Two identical half bases make up a Buss modular fuse base. These “split” units can be panel mounted any distance apart to accommodate any length fuse.

### Stud Type

The simpler design is the C5268 series modular fuse base. With this design, the fuse terminal and cable (with termination) are mounted on the same stud, minimizing labor needed for installation. The stud type base is available in the configuration shown in the table below.

Part No.	Max. Fuse Current Rating	Stud Heights	Stud Dia. & Threads
C5268-1	200A	1.00"	5/16-18
C5268-2	200A	1.75"	5/16-18
C5268-3	200A	0.75"	5/16-18
C5268-4	100A	1.00"	1/4-20
C5268-5	100A	1.75"	1/4-20

### Connector Type

Bussmann also offers a modular style fuse base that utilizes a tin-plated connector (for wire termination and heat dissipation) and a plated-steel stud (for fuse mounting). The connector type fuse base is available in the configurations shown below. Consult Bussmann for additional product details.

Modular Base Style	Max. Voltage	Max. Fuse Current Rating	BIF Document
1BS101	600V	100A	1206
1BS102	600V	400A	1207
1BS103	600V	400A	1208
1BS104	600V	600A	1209
BH-0xxx	700V	100A	1200
BH-1xxx	2500V	400A	1201
BH-2xxx	5000V	400A	1202
BH-3xxx	1250V	700A	1203

### Fixed Center Base Style

Bussmann offers a comprehensive line of fixed mount style fuse bases under the trademark TRON® rectifier fuseblocks. The cable and fuse connections are similar to the stud type fuse base — both are mounted on the same stud. Consult Bussmann for complete product details.

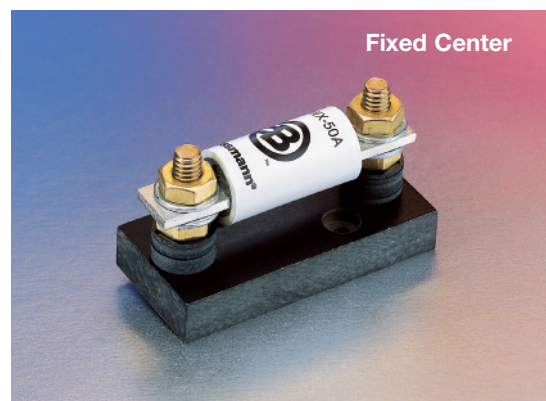
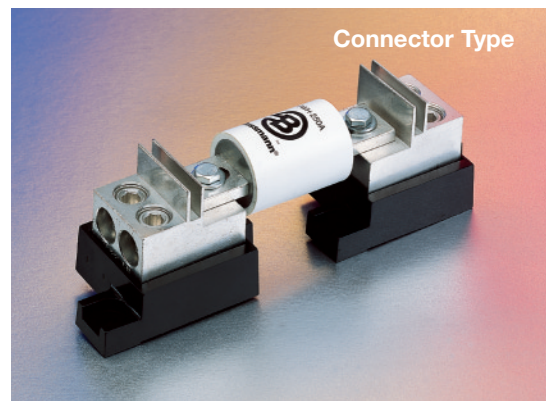
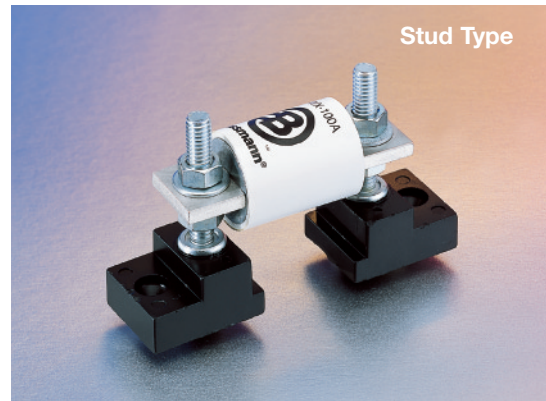



## North American Curves

### FWA-130V (1000-4000)AH Time-Current Curve

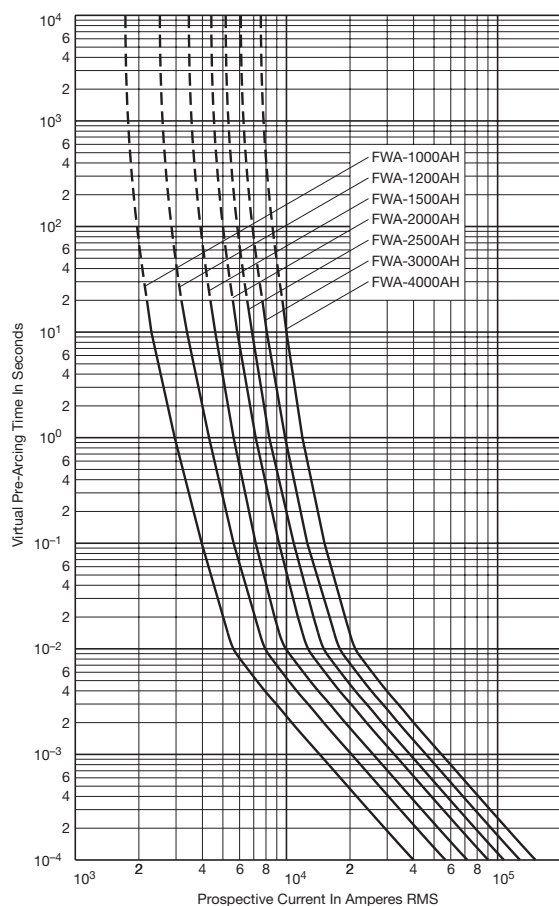

#### Peak Let-Through Curve

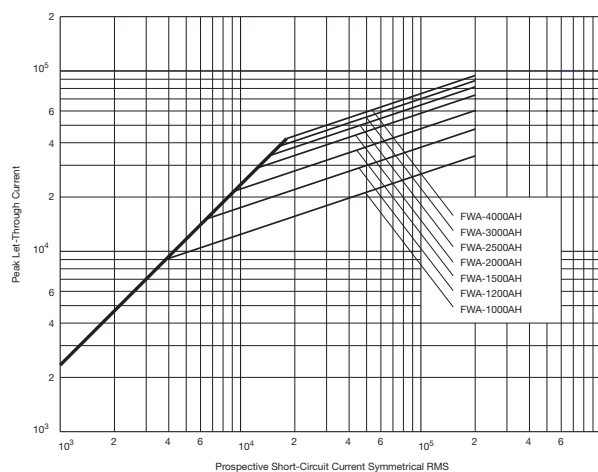

### FWA-150V (70-1000)A Time-Current Curve

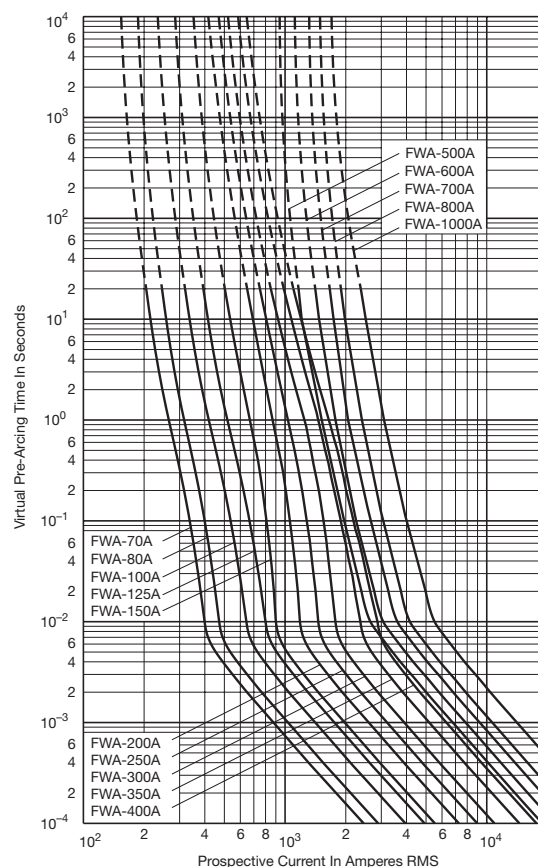

#### Peak Let-Through Curve

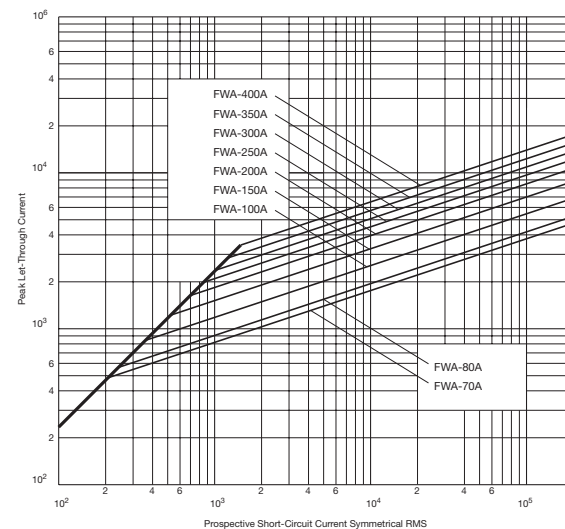

BIF document: 35785301

BIF document: 35785310





# North American Curves

## FWX 250V (35-800)A Time-Current Curve

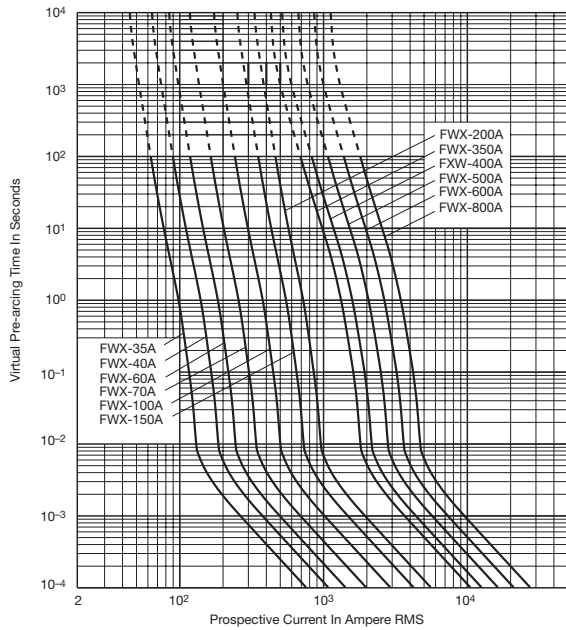

## FWX 250V (1000-2500)AH Time-Current Curve

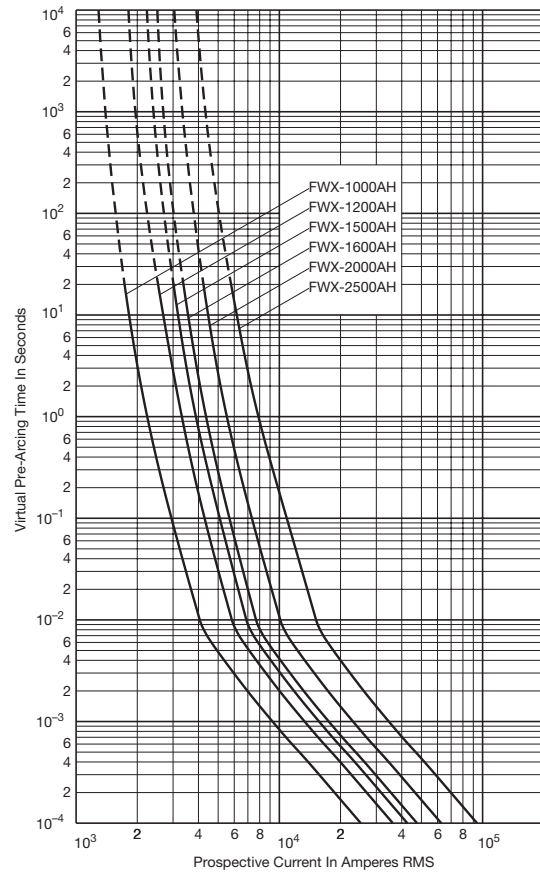

## Peak Let-Through Curve

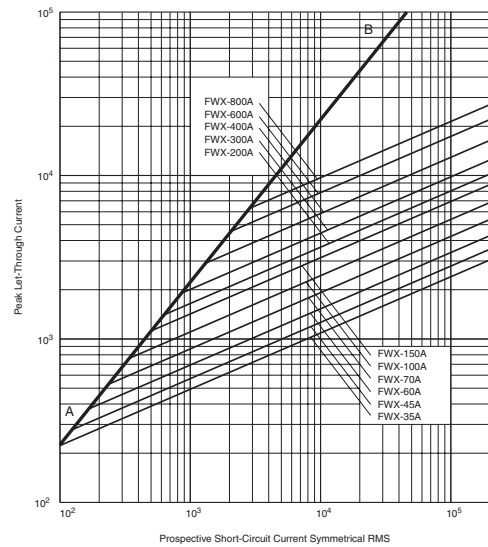

## Peak Let-Through Curve

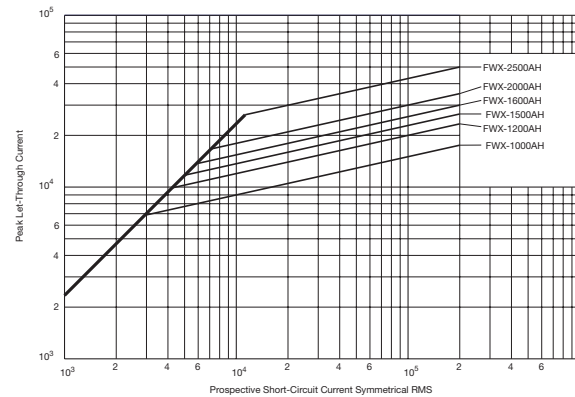

BIF document: 359

BIF document: 35785299





## North American Curves

### FWH 500V (35-200)B & (900-1600)A Time-Current Curve

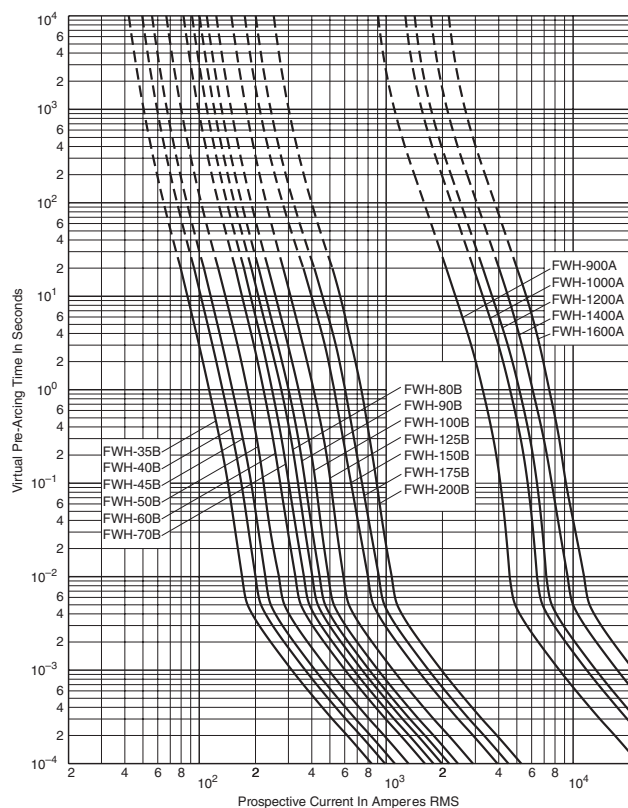

### FWH 500V (225-800)A Time-Current Curve

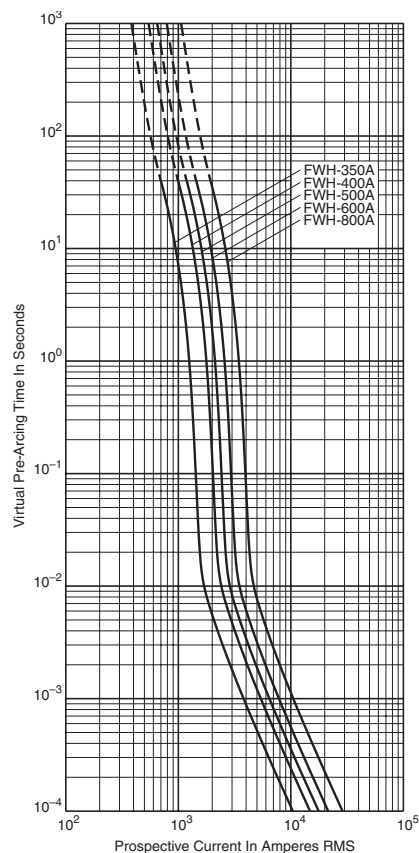

### Peak Let-Through Curve

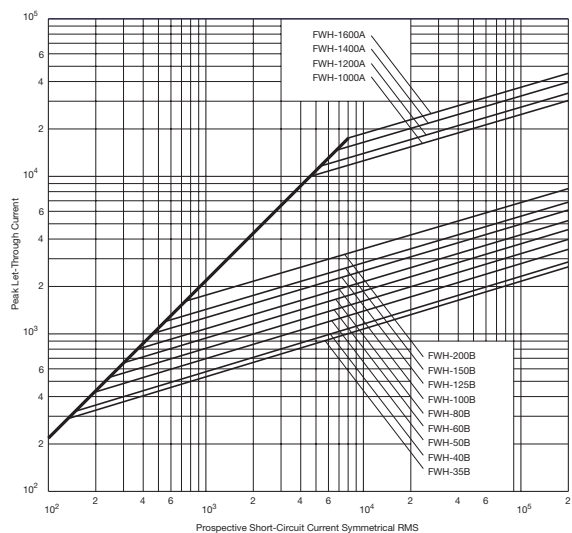

### Peak Let-Through Curve

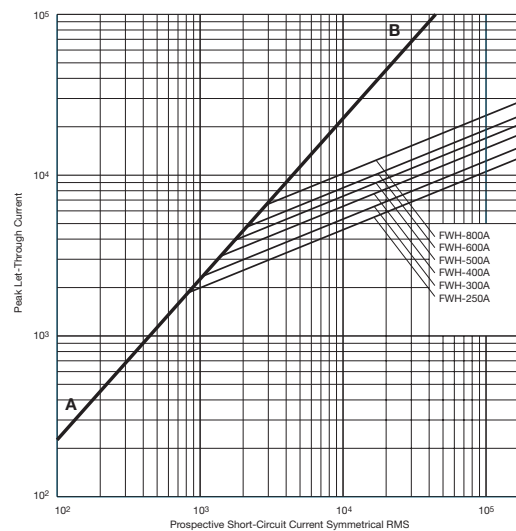

BIF document: 35785304

BIF document: 360



For complete specification data, visit our Web site at [www.bussmann.com](http://www.bussmann.com)  
or call Bussmann Information Fax ~ 636.527.1450





## North American Curves

### FWP 700V (5-30)B Time-Current Curve

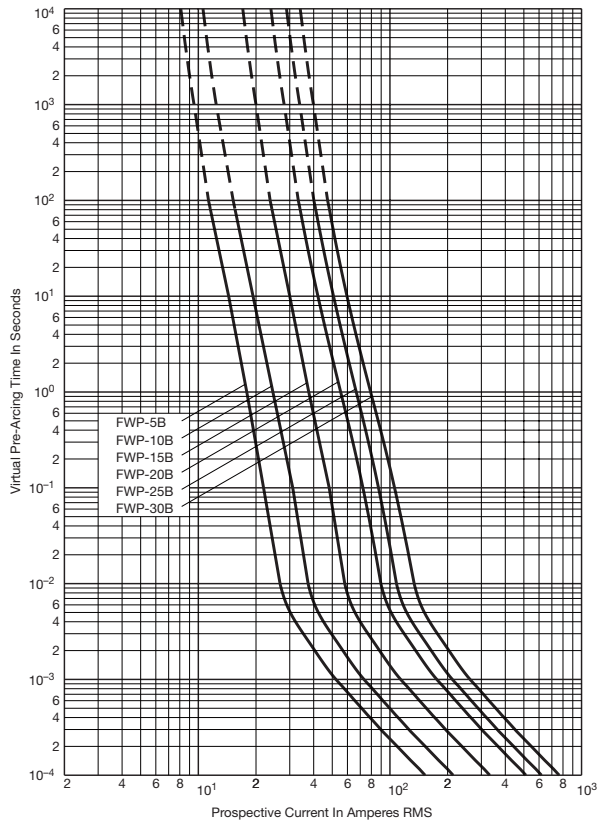

### Peak Let-Through Curve

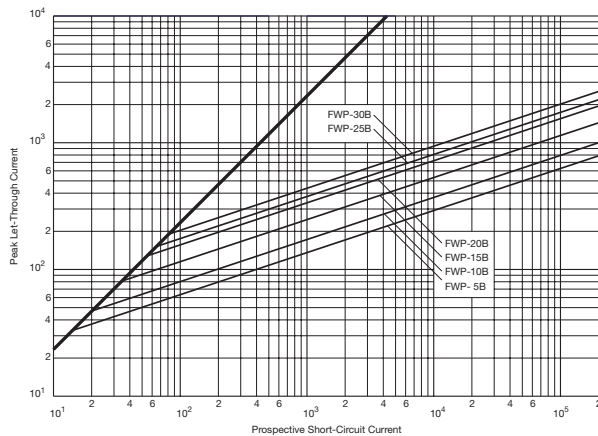

BIF document: 35785316

### FWP 700V (35-100)B & (700-1200)A Time-Current Curve

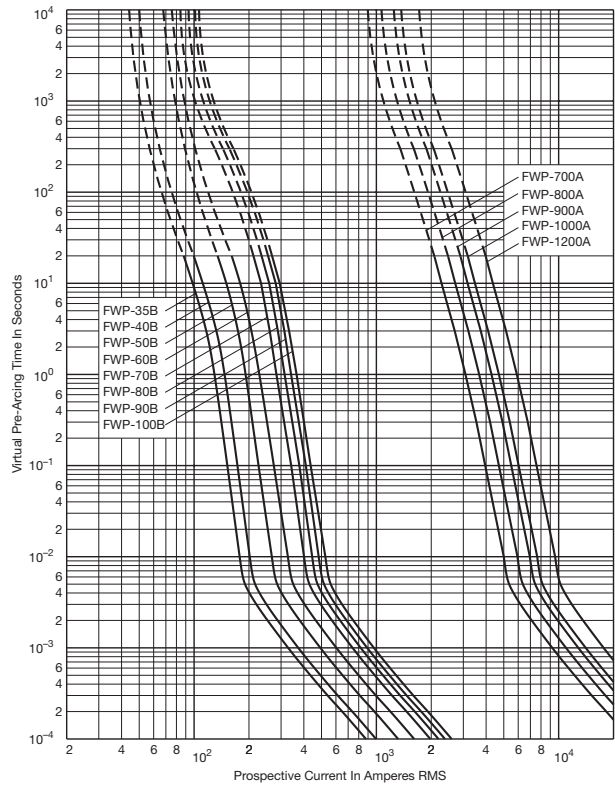

### Peak Let-Through Curve

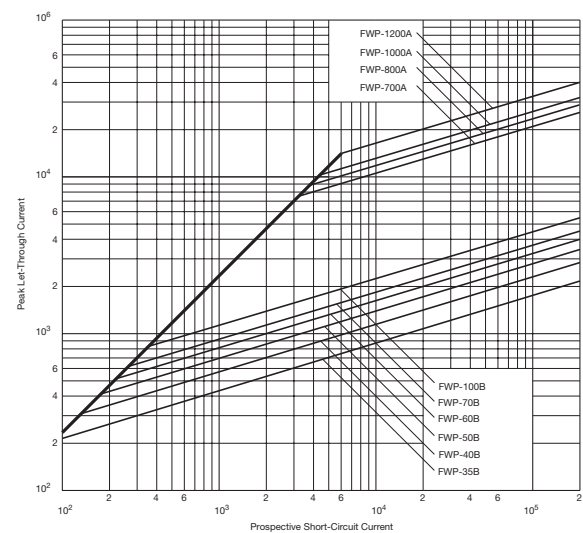

BIF document: 35785308







## North American Curves

### FWP 700V (125-600)A Time-Current Curve

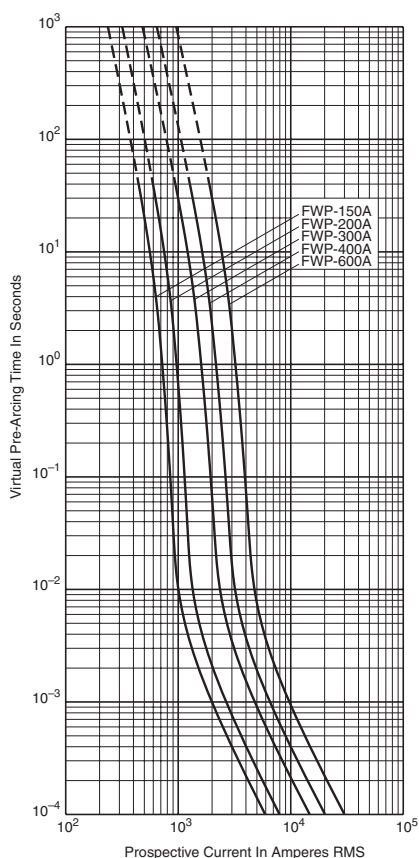

### FWJ 1000V (35-600)A Time-Current Curve

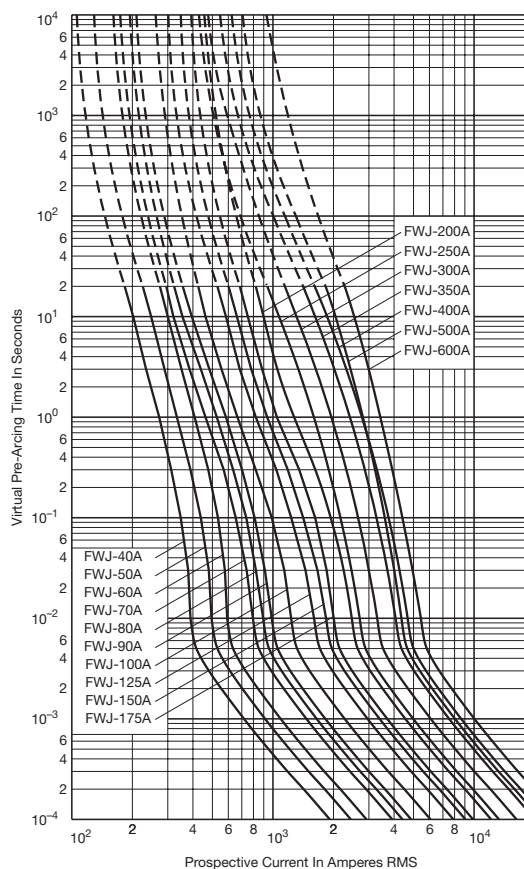

### Peak Let-Through Curve

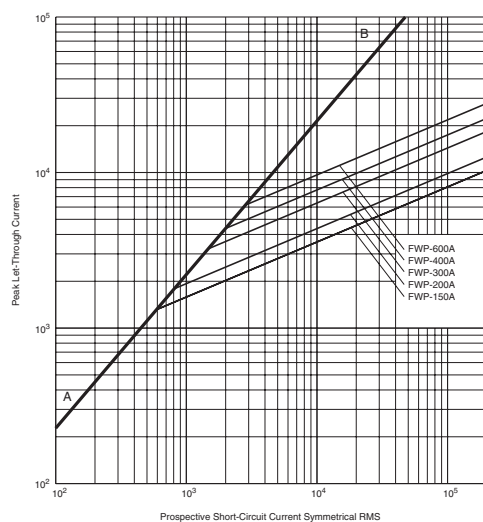

### Peak Let-Through Curve

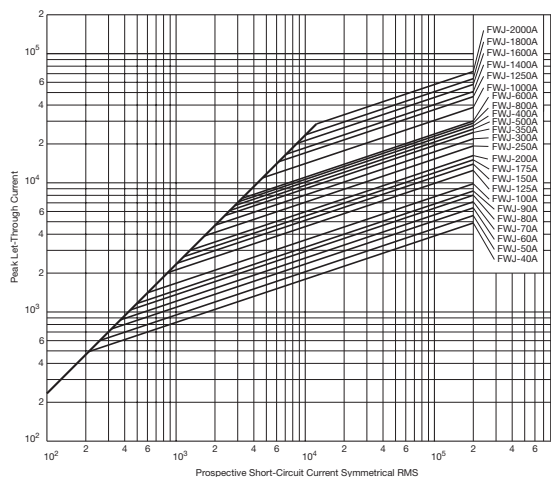

BIF document: 361

BIF document: 35785303



For complete specification data, visit our Web site at [www.bussmann.com](http://www.bussmann.com)  
or call Bussmann Information Fax ~ 636.527.1450



## North American Curves

### FWJ 1000V (800-2000)A

#### Time-Current Curve

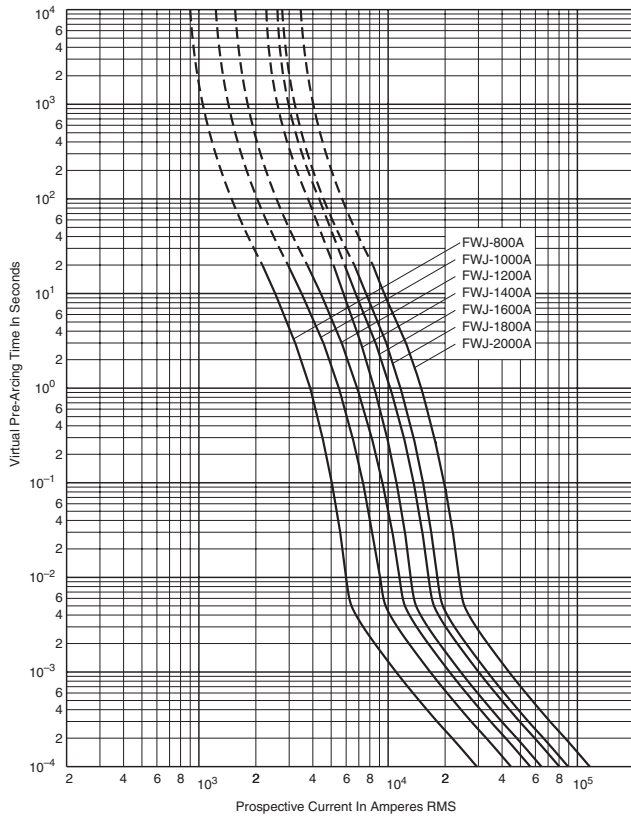



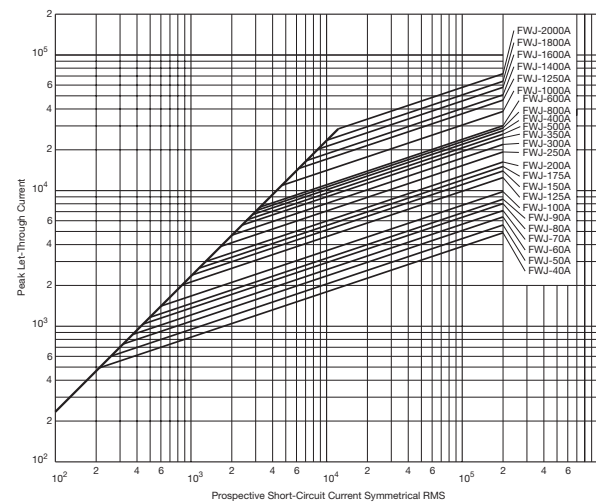

#### Peak Let-Through Curve



BIF document: 35785309



## Table of Contents

<b>General Applications</b>	<b>2-4</b>		
 <b>North American</b>	<b>5</b>	 <b>British BS 88</b>	<b>79</b>
FWA 130V 1000-4000A	6-7	240V 6-900A	80-81
FWA 150V 70-1000A	8-9	690V 6-700A	82-83
FWX 250V 35-2500A	10-11	Accessories	84
FWH 500V 35-1600A	12-13	Time-Current & Peak Let-Through Curves	85-89
KAC 600V 1-1000A	14		
KBC 600V 35-800A	15	 <b>Ferrule</b>	<b>91</b>
FWP 700V 5-1200A	16-17	FWA 150V 5-60A	92
FWJ 1000V 35-2000A	18-19	FWX 250V 1-30A	93
Accessories	20	FWH 500V 0.25-30A	94-95
Time-Current & Peak Let-Through Curves	21-26	FWC 600V 6-32A	96
		FWP 660V/700V 1-100A	97-98
 <b>Square Body</b>	<b>27</b>	FWK 750V 5-60A	99
Applications	28-29	FWJ 1000V 20-30A	100
DIN 43 653	30-43	FWL/FWS 1250/1500/2000V 2-30A	101
DIN 43 620	44-49	Accessories	102
Flush End Contact	50-59	Time-Current & Peak Let-Through Curves	103-108
French Style	60-61		
US Style	62-67		
Accessories	68-69		
Time-Current & Peak Let-Through Curves	70-78		

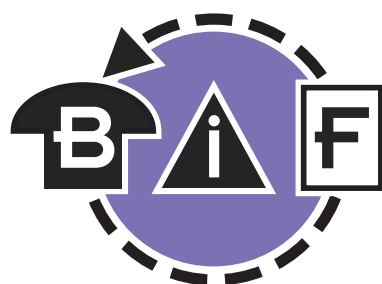

**Bussmann  
Information Fax ~  
636.527.1450**

**Get the latest, most up-to-date specification data on products listed in this catalog by calling Bussmann Information Fax.**

**BIF** is a simple to use automated fax response system. No need to wait for normal business hours; **BIF** is available around the clock for your convenience. All you need is a touch-tone telephone and a fax machine to get specification data when you want it.

A **BIF** document number is indicated with each product in this catalog. To get a detailed specification sheet simply call **636-527-1450** and follow the prompts. In a matter of minutes, a data sheet will be faxed to you. It's that simple!

**Bussmann Worldwide Web ~ <http://www.bussmann.com>**



# Square Body

## Introduction



## Table of Contents

	Voltage	Page
<b>Applications</b>		28-29
<b>Fuse Style</b>		
DIN 43 653	690V	30-35
	1000V	36-39
	1250V	40-43
DIN 43 620	690V	44-47
	1000V	48-49
Flush End Contact	690V	50-55
	1000V	56-57
	1250V	58-59
French Style	690V	60-61
US Style	690V	62-63
	1000V	64-65
	1250V	66-67
<b>Accessories</b>		
Indicator System		68
Fuse Bases		69
<b>Curves</b>		
Time-Current & Peak Let-Through		70-78

## General Information

Designed and tested to:

- IEC 60269: Part 4
- U.L. Recognized

Bussmann offers a complete range of Square Body style fuses and accessories. Their unique design and construction provide:

- Minimal energy let-through ( $I^2t$ )
- Low operating temperature
- Low watts loss

Square Body style fuses are a very attractive solution for high power applications which require a compact design with superior performance. The construction and design of Square Body style fuses make it easy for Bussmann to manufacture custom products. Our cataloged offering provides only a sample of the wide variety of product which is available.

Each Square Body style fuse is available with a number of different end fittings. Options include:

- DIN 43 653
- DIN 43 620
- Flush End (Metric/U.S.)
- French Style
- US Style

### Voltage Rating

All Bussmann Square Body style fuses are tested to IEC 60269: Part 4. This standard requires a test voltage which is 5% higher than the rated voltage. In North America, fuses are required to clear only their rated voltage.

### Accessories

Square Body style fuses are available with three different open fuse indicator systems. Options include visual indication and indication utilizing a microswitch. Fuseblocks are also available for most applications.

Voltage	AC	DC	Ampere Range
690	X	—	10-7500
1000	X	—	20-1400
1250	X	—	50-1400





## Square Body Applications

### Maximum Permissible Load Current

The rated current value of Bussmann fuses is based on the ambient temperature in the space immediately below the fuse of 20°C. The following graph gives correction factors (k) for a range of temperatures (-40°C to +80°C). Maximum permissible continuous load currents can be calculated by applying the following formula:

$$I_b \leq I_n \times k \times (1 + 0.05 V) \times K_b$$

where

- $I_b$  = Maximum permissible continuous load current
- $I_n$  = Rated current of fuse
- $k$  = Temperature correction factor
- $v$  = Velocity of cooling air in m/s (max. 5 m/s).
- $K_b$  = Fuse load constant 1.0

The maximum permissible continuous load current  $I_b$  of a fuse can be checked empirically (i.e., by satisfying the formula below) by making simple voltage and temperature measurements under actual operating conditions after the fuse has been installed in its operating location and loaded at the calculated  $I_b$  value:

$$\frac{E_2}{E_1} \times (0.92 + 0.004t) \leq N$$

where

- $E_1$  = Voltage drop across fuse after 5 seconds
- $E_2$  = Voltage drop across fuse after 2 hours
- $t$  = Air temperature at start of test (°C)
- $N$  = Constant





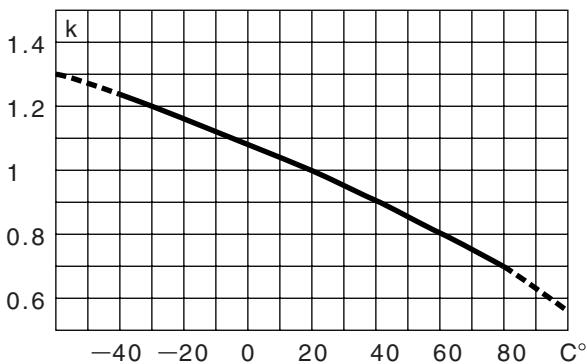

Fuse Rated Voltage (IEC)	N
690	1.5
1250	1.6

Temperature Correction Curve



### Body Cross Section

Standard fuse program includes barrels with different cross sections.

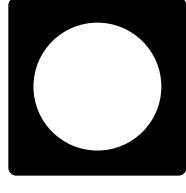
Size	000	00	1*	1	2	3	4
Maximum Cross-section mm	21 × 36	30 × 47	45 × 45	53 × 53	61 × 61	76 × 76	105 × 105
							





## Square Body Applications

### Example Application of Square Body High Speed Fuses Subject to Overload and Impulse Loading

Select a short-blade indicating fuse with indicator/adaptor to permit the use of a single-pole microswitch for remote indication and determine if the fuse selected will meet the following application parameters.

#### Application Parameters

##### Load Currents Expected

Load Type	Duration	Frequency of Occurrence	Amperes
(1) Normal	Continuous	—	300A
(2) Overload	60 Seconds	Once Per Hour	500A
(3a) Overload	10 Seconds	2-3 Times Per Week	700A
(3b) Overload	20 Seconds (max.)	Once Per Month	
(4) Impulse	0.5 Seconds	Less Than Once Per Month	1100A

##### Voltage Data

(5) Voltage Applied to Fuse During Fault Conditions	400V (+10%)
---	-------------

##### Temperature Data

(6) Temperature Inside Cubicle in Which Fuse is Located (Natural Convection Cooling Only)	60°C
---	------

##### Thyristor Data

(7) Thyristor Peak Voltage Withstand	1000V
(8) Thyristor $I^2t$ Withstand at 10 Milliseconds*	90,000A <sup>2</sup> s

\*Note: The  $I^2t$  withstand of the thyristor may be given for other impulse durations (i.e., 1.5 ms, 3.5 ms, or 8.3 ms); however, the stated fuse  $I^2t$  is valid for all impulse durations of 10 ms or less.

#### Application Procedure

Step	Procedure	Remarks
(1) Select a short-blade fuse to permit mounting of microswitch MSW710-1S or 170H0069	1.1 Taking into consideration only the continuous load current and ambient temperature, from Table on page 54 tentatively select fuse 170M3669 400A, 690V.	—
(2) Determine $I^2t$ (total clearing) at 440V.	2.1 See Table, page 54. Note $I^2t$ is 105,000A <sup>2</sup> s at rated voltage of 660V. 2.2 From the figure on page 55, note that correction factor $K = 0.65$ . 2.3 $I^2t_{660V} \times K = I^2t_{440V}$ $105,000 \times 0.65 = 68,250$	OK
(3) Determine maximum arc voltage at 440V	3.1 From the figure on page 55, note that maximum voltage at 440V is 925V	OK
(4) Determine maximum permissible continuous load current $I_b$ .	4.1 Per page 28 data, $I_b = I_n \times k \times (1 + 0.05V) \times K_p$ $I_b = 400A \times 0.8 \times (1 + 0) \times 1$ $I_b = 320A$	—
(5) Plot a "line profile" showing the expected load and overload currents. Determine that overload and impulse load currents do not exceed their maximum permissible values.	5.0 Calculate $I_{max}$ per Table, page 4, for each overload and impulse load.	—
(Item 2)	5.1 $I_{max} < 60\% \times I_t$ $500A < 60\% \times 950A$ $500A < 570A$	OK
(Item 3a)	5.2 $I_{max} < 60\% \times I_t$ $700A < 60\% \times 1360A$ $700A < 780A$	OK
(Item 3b)	5.3 $I_{max} < 70\% \times I_t$ $700A < 70\% \times 1150A$ $700A < 805A$	OK
(Item 4)	5.4 $I_{max} < 70\% \times I_t$ $1100A < 70\% \times 1800A$ $1100A < 1260A$	OK

The tentatively selected fuse 170M3669 with microswitch 170H0069 meets all application parameters; no further selection would be necessary.

170M3669 (400A)

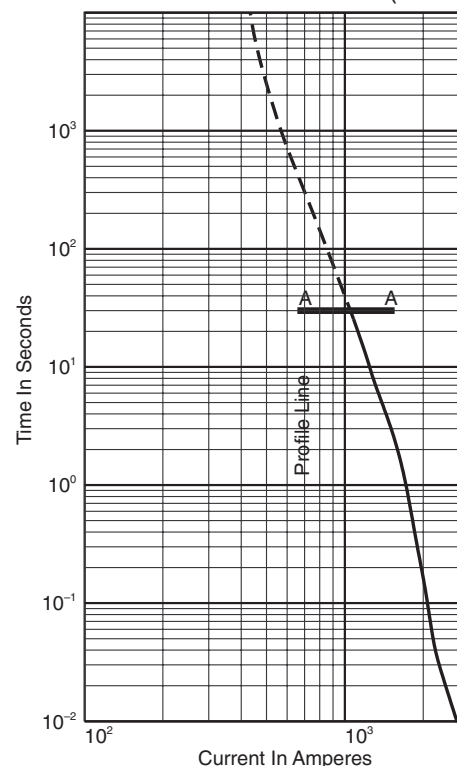

#### Calculation of Watt Loss

From the Table on page 54, watt loss at 400 amperes is 60 watts. The continuous load current of 300 amperes is 75% of rated current (400 amperes). From page 55, the correction factor  $K_p = 0.5$ .  

$$\text{Watt Loss}_{75\%} = \text{Watt Loss}_{100\%} \times K_p$$

$$= 60W \times 0.5$$

$$= 30 \text{ watts}$$

#### Special Fuses

Other high speed fuses are available from Bussmann with voltage ratings of 380 to 10,000 volts and current ratings up to 10,000 Amp in a single unit configuration. Fuses can be supplied with open fuse, "pin" indicators. Various types of microswitches are also available (see page 58).







# Square Body - DIN 43 653 690V/700V (IEC/U.L.) 10-400A



Electrical Characteristics					Ordering Information			Curves		
Size	Rated Current RMS-Amps	I <sup>2</sup> t (A <sup>2</sup> Sec)		Watts Loss	-U/80 Without Indicator	-/80 Visual Indicator	-TN/80 Type T Indicator for Micro	Carton Qty.	Weight (kg)	See Page or (Datasheet)
		Pre-arc	Clearing at 660V							
000	10	3.8	25.5	3.0	170M1308	170M1358	170M1408	10	1.34	page 70 (720048)
	16	7.2	48	5.5	170M1309	170M1359	170M1409			
	20	11.5	78	7	170M1310	170M1360	170M1410			
	25	19	130	9	170M1311	170M1361	170M1411			
	32	40	270	10	170M1312	170M1362	170M1412			
	40	69	460	12	170M1313	170M1363	170M1413			
	50	115	770	15	170M1314	170M1364	170M1414			
	63	215	1450	16	170M1315	170M1365	170M1415			
	80	380	2550	19	170M1316	170M1366	170M1416			
	100	695	4650	24	170M1317	170M1367	170M1417			
	125	1200	8500	28	170M1318	170M1368	170M1418			
	160	2300	16000	32	170M1319	170M1369	170M1419			
	200	4200	28000	37	170M1320	170M1370	170M1420			
	250	7750	51500	42	170M1321	170M1371	170M1421			
315	12000	80500	52	170M1322	170M1372	170M1422				
00	25	19	130	6		170M2608	170M2658	5	1.05	page 70 (720049)
	32	28.5	195	7		170M2609	170M2659			
	40	50	360	9		170M2610	170M2660			
	50	95	640	10		170M2611	170M2661			
	63	170	1200	12		170M2612	170M2662			
	80	310	2100	15		170M2613	170M2663			
	100	620	4150	20		170M2614	170M2664			
	125	1000	6950	25		170M2615	170M2665			
	160	1900	13000	30		170M2616	170M2666			
	200	3400	23000	35		170M2617	170M2667			
	250	6250	42000	45		170M2618	170M2668			
	315	10000	68500	55		170M2619	170M2669			
	350	13500	91500	60		170M2620	170M2670			
	400	18000	125000	70		170M2621	170M2671			

† U.L. Recognition/CSA Component Acceptance on Size 000.

1 kg = 2.2 lbs. 1 lb = 0.45 kg

- Interrupting rating 200kA (Estimated 300kA) RMS Symmetrical.
- Watts loss provided at rated current.
- Microswitch indicator ordered separately. See accessories on pages 68-69.





**Square Body - DIN 43 653**

**690V/700V (IEC/U.L.) 10-400A**



**Electrical Characteristics**

**Total Clearing I<sup>2</sup>t**

The total clearing I<sup>2</sup>t at rated voltage and at power factor of 15% are given in the electrical characteristics. For other voltages, the clearing I<sup>2</sup>t is found by multiplying by correction factor, K, given as a function of applied working voltage, E<sub>g</sub>, (RMS).

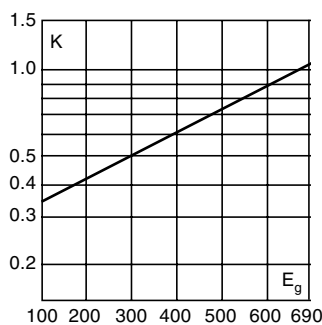

**Arc Voltage**

This curve gives the peak arc voltage, U<sub>L</sub>, which may appear across the fuse during its operation as a function of the applied working voltage, E<sub>g</sub>, (RMS) at a power factor of 15%.

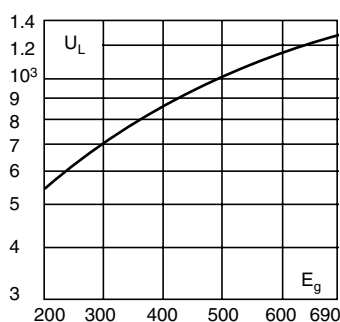

**Power Losses**

Watts loss at rated current is given in the electrical characteristics. The curve allows the calculation of the power losses at load currents lower than the rated current. The correction factor, K<sub>p</sub>, is given as a function of the RMS load current, I<sub>b</sub>, in % of the rated current.

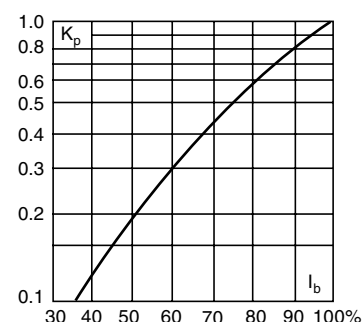

**Dimensions**

DIN 43 653: Type -U/80, -/80, -TN/80

Size	D	E	F	G	H	K
000	40	21	20	51	8	2
00	51	30	28	67	10	2

Dimension in mm.  
1mm = 0.0394" 1" = 25.4mm

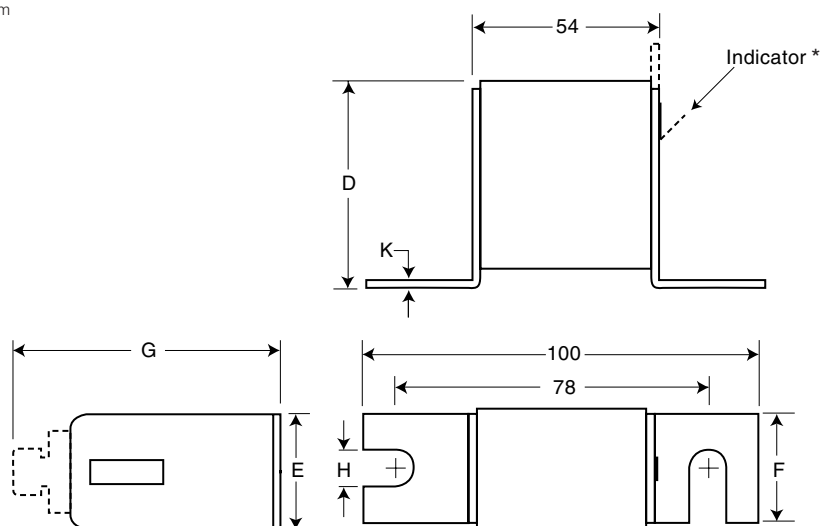

\* Indication for Size 00 fuses is a red pin.







# Square Body - DIN 43 653 690V/700V (IEC/U.L.) 40-2000A



Size	Electrical Characteristics				Ordering Information				Curves				
	Rated Current RMS-Amps	I <sup>2</sup> t (A <sup>2</sup> S)		Watts Loss	-/80 Visual Indicator	-TN/80 Type T Indicator for Micro	-/110 Visual Indicator	-TN/110 Type T Indicator for Micro	Carton Qty.	Carton Weight (kg)	See Page or (Datasheet)		
		Pre-arc	Clearing at 660V										
1*	40	40	270	9	170M3008	170M3058	170M3158	170M3208	5	1.50	page 71 (720050)		
	50	77	515	11	170M3009	170M3059	170M3159	170M3209					
	63	115	770	14	170M3010	170M3060	170M3160	170M3210					
	80	185	1250	18	170M3011	170M3061	170M3161	170M3211					
	100	360	2450	21	170M3012	170M3062	170M3162	170M3212					
	125	550	3700	26	170M3013	170M3063	170M3163	170M3213					
	160	1100	7500	30	170M3014	170M3064	170M3164	170M3214					
	200	2200	15000	35	170M3015	170M3065	170M3165	170M3215					
	250	4200	28500	40	170M3016	170M3066	170M3166	170M3216					
	315	7000	46500	50	170M3017	170M3067	170M3167	170M3217					
	350	10000	68500	55	170M3018	170M3068	170M3168	170M3218					
	400	15000	105000	60	170M3019	170M3069	170M3169	170M3219					
	450	21000	140000	65	170M3020	170M3070	170M3170	170M3220					
	500	27000	180000	70	170M3021	170M3071	170M3171	170M3221					
550	34000	230000	75	170M3022	170M3072	170M3172	170M3222						
630	48500	325000	80	170M3023	170M3073	170M3173	170M3223						
1	200	1650	11500	45	170M4008	170M4058	170M4158	170M4208	3 (-/80)	1.29	page 71 (720051)		
	250	3100	21000	55	170M4009	170M4059	170M4159	170M4209					
	315	6200	42000	58	170M4010	170M4060	170M4160	170M4210					
	350	8500	59000	60	170M4011	170M4061	170M4161	170M4211	2 (-/110)			0.94	
	400	13500	91500	65	170M4012	170M4062	170M4162	170M4212					
	450	17000	120000	70	170M4013	170M4063	170M4163	170M4213					
	500	25000	170000	72	170M4014	170M4064	170M4164	170M4214					
	550	34000	230000	75	170M4015	170M4065	170M4165	170M4215					
	630	52000	350000	80	170M4016	170M4066	170M4166	170M4216					
	700	69500	465000	85	170M4017	170M4067	170M4167	170M4217					
	800	105000	725000	95	170M4018	170M4068	170M4168	170M4218					
±900	155000	±850000	100	170M4019	170M4069	170M4169	170M4219						
2	400	11000	74000	65	170M5008	170M5058	170M5158	170M5208	2	1.20	page 72 (720052)		
	450	15500	105000	70	170M5009	170M5059	170M5159	170M5209					
	500	21500	145000	75	170M5010	170M5060	170M5160	170M5210					
	550	28000	190000	80	170M5011	170M5061	170M5161	170M5211					
	630	41000	275000	90	170M5012	170M5062	170M5162	170M5212					
	700	60500	405000	95	170M5013	170M5063	170M5163	170M5213					
	800	86000	575000	105	170M5014	170M5064	170M5164	170M5214					
	900	125000	840000	110	170M5015	170M5065	170M5165	170M5215					
	1000	180000	1250000	115	170M5016	170M5066	170M5166	170M5216					
	1100	245000	1600000	120	170M5017	170M5067	170M5167	170M5217					
1250	365000	2400000	130	170M5018	170M5068	170M5168	170M5218						
3	500	14000	95000	95	170M6008	170M6058	170M6158	170M6208	2 (-/80)	1.66	page 72 (720053)		
	550	19500	135000	100	170M6009	170M6059	170M6159	170M6209					
	630	31000	210000	105	170M6010	170M6060	170M6160	170M6210					
	700	44500	300000	110	170M6011	170M6061	170M6161	170M6211	1 (-/110)			0.89	
	800	69500	465000	115	170M6012	170M6062	170M6162	170M6212					
	900	100000	670000	120	170M6013	170M6063	170M6163	170M6213					
	1000	140000	945000	125	170M6014	170M6064	170M6164	170M6214					
	1100	190000	1300000	130	170M6015	170M6065	170M6165	170M6215					
	1250	290000	1950000	140	170M6016	170M6066	170M6166	170M6216					
	1400	370000	2450000	155	170M6017	170M6067	170M6167	170M6217					
	1500	460000	3100000	160	170M6018	170M6068	170M6168	170M6218					
	1600	580000	3900000	160	170M6019	170M6069	170M6169	170M6219					
	†1800	880000	†5250000	165	170M6020	170M6070	170M6170	170M6220					
‡2000	1150000	‡6350000	175	170M6021	170M6071	170M6171	170M6221						

- Interrupting rating 200kA (Estimated 300kA)RMS Symmetrical.
- Watts loss provided at rated current.
- Rated voltage (IEC) †600V ‡550V (Consult Bussmann for U.L. Recognition/ CSA Component Acceptance status.)
- Microswitch indicator ordered separately. See accessories on pages 68-69.

1 kg = 2.2 lbs. 1 lb = 0.45 kg





**Square Body – DIN 43 653**

**690V/700V (IEC/U.L.) 40-2000A**



**Electrical Characteristics**

**Total Clearing I²t**

The total clearing I²t at rated voltage and at power factor of 15% are given in the electrical characteristics. For other voltages, the clearing I²t is found by multiplying by correction factor, K, given as a function of applied working voltage, E<sub>g</sub>, (RMS).

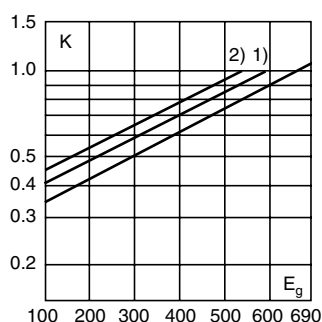

1) Rated voltage 600V  
2) Rated voltage 550V

**Arc Voltage**

This curve gives the peak arc voltage, U<sub>L</sub>, which may appear across the fuse during its operation as a function of the applied working voltage, E<sub>g</sub>, (RMS) at a power factor of 15%.

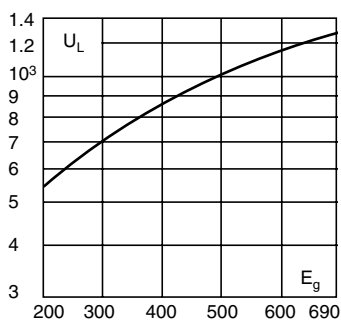

**Power Losses**

Watts loss at rated current is given in the electrical characteristics. The curve allows the calculation of the power losses at load currents lower than the rated current. The correction factor, K<sub>p</sub>, is given as a function of the RMS load current, I<sub>b</sub>, in % of the rated current.

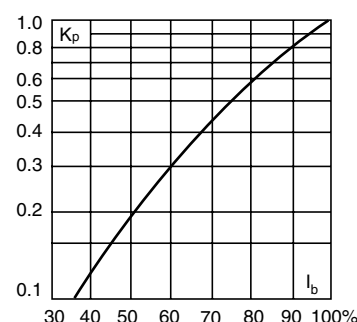

**Dimensions**

DIN 43 653: Type -/80, -TN/80, -/110, -TN/110

Size	A	B	B§	C	C§	D	E	H
1*	50	104	134	78	108	58	45	22
1	50	108	138	78	108	66	53	25
2	50	108	138	78	108	75	61	25
3	51	109	139	78	108	90	76	30

§Valid for fuses type -/110, -TN/110

Dimension in mm.

1mm = 0.0394" 1" = 25.4mm

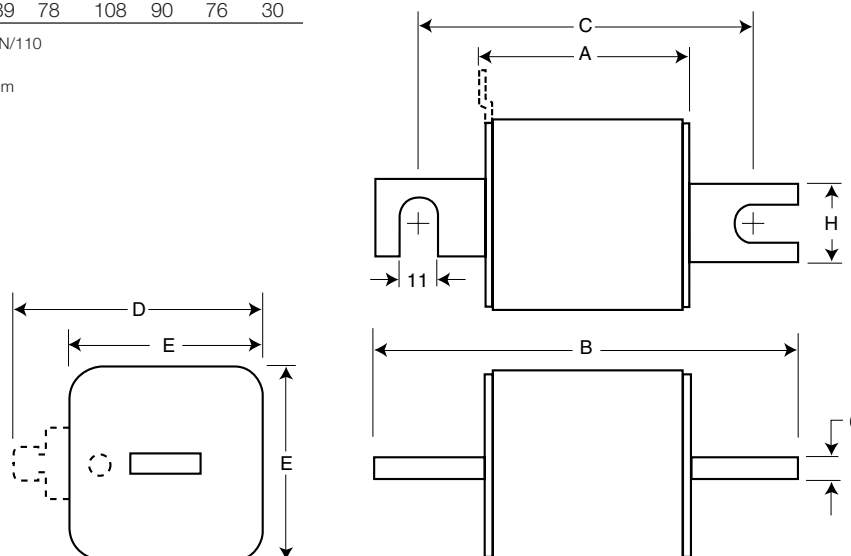



# Square Body - DIN 43 653 690V/700V (IEC/U.L.) 40-2000A



Electrical Characteristics					Ordering Information			Curves					
Size	Rated Current RMS-Amps	I <sup>2</sup> t (A <sup>2</sup> S)		Watts Loss	-KN/80 Type K Indicator for Micro	-KN/110 Type K Indicator for Micro	Carton Qty.	Carton Weight (kg)	See Page or (Datasheet)				
		Pre-arc	Clearing at 660V										
1*	40	40	270	9	170M3108	170M3258	5	1.60	page 71 (720054)				
	50	77	515	11	170M3109	170M3259							
	63	115	770	14	170M3110	170M3260							
	80	185	1250	18	170M3111	170M3261							
	100	360	2450	21	170M3112	170M3262							
	125	550	3700	26	170M3113	170M3263							
	160	1100	7500	30	170M3114	170M3264							
	200	2200	15000	35	170M3115	170M3265							
	250	4200	28500	40	170M3116	170M3266							
	315	7000	46500	50	170M3117	170M3267							
	350	10000	68500	55	170M3118	170M3268							
	400	15000	105000	60	170M3119	170M3269							
	450	21000	140000	65	170M3120	170M3270							
	500	27000	180000	70	170M3121	170M3271							
550	34000	230000	75	170M3122	170M3272								
630	48500	325000	80	170M3123	170M3273								
1	200	1650	11500	45	170M4108	170M4258	3 (-/80)	1.38	page 71 (720055)				
	250	3100	21000	55	170M4109	170M4259							
	315	6200	42000	58	170M4110	170M4260							
	350	8500	59000	60	170M4111	170M4261							
	400	13500	91500	65	170M4112	170M4262	2 (-/110)	1.00					
	450	17000	120000	70	170M4113	170M4263							
	500	25000	170000	72	170M4114	170M4264							
	550	34000	230000	75	170M4115	170M4265							
	630	52000	350000	80	170M4116	170M4266							
	700	69500	465000	85	170M4117	170M4267							
	800	105000	725000	95	170M4118	170M4268							
	†900	155000	†850000	100	170M4119	170M4269							
	2	400	11000	74000	65	170M5108				170M5258	2	1.26	page 72 (720056)
		450	15500	105000	70	170M5109				170M5259			
500		21500	145000	75	170M5110	170M5260							
550		28000	190000	80	170M5111	170M5261							
630		41000	275000	90	170M5112	170M5262							
700		60500	405000	95	170M5113	170M5263							
800		86000	575000	105	170M5114	170M5264							
900		125000	840000	110	170M5115	170M5265							
1000		180000	1250000	115	170M5116	170M5266							
1100		245000	1600000	120	170M5117	170M5267							
1250	365000	2400000	130	170M5118	170M5268								
3	500	14000	95000	95	170M6108	170M6258	1	0.92	page 72 (720057)				
	550	19500	135000	100	170M6109	170M6259							
	630	31000	210000	105	170M6110	170M6260							
	700	44500	300000	110	170M6111	170M6261							
	800	69500	465000	115	170M6112	170M6262							
	900	100000	670000	120	170M6113	170M6263							
	1000	140000	945000	125	170M6114	170M6264							
	1100	190000	1300000	130	170M6115	170M6265							
	1250	290000	1950000	140	170M6116	170M6266							
	1400	370000	2450000	155	170M6117	170M6267							
	1500	460000	3100000	160	170M6118	170M6268							
	1600	580000	3900000	160	170M6119	170M6269							
	†1800	880000	†5250000	165	170M6120	170M6270							
	‡2000	1150000	‡6350000	175	170M6121	170M6271							

- Interrupting rating 200kA (Estimated 300kA) RMS Symmetrical.
- Watts loss provided at rated current.
- Rated voltage (IEC) †600V ‡550V (Consult Bussmann for U.L. Recognition/ CSA Component Acceptance status.)
- Microswitch indicator ordered separately. See accessories on pages 68-69.

1 kg = 2.2 lbs. 1 lb = 0.45 kg





**Square Body - DIN 43 653**

**690V/700V (IEC/U.L.) 40-2000A**



**Electrical Characteristics**

**Total Clearing I²t**

The total clearing I²t at rated voltage and at power factor of 15% are given in the electrical characteristics. For other voltages, the clearing I²t is found by multiplying by correction factor, K, given as a function of applied working voltage, E<sub>g</sub>, (RMS).

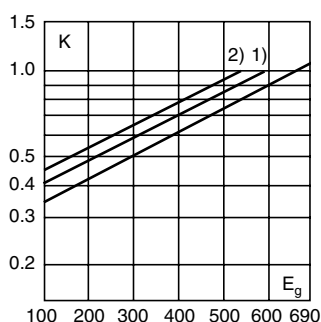

1) Rated voltage 600V  
2) Rated voltage 550V

**Arc Voltage**

This curve gives the peak arc voltage, U<sub>L</sub>, which may appear across the fuse during its operation as a function of the applied working voltage, E<sub>g</sub>, (RMS) at a power factor of 15%.

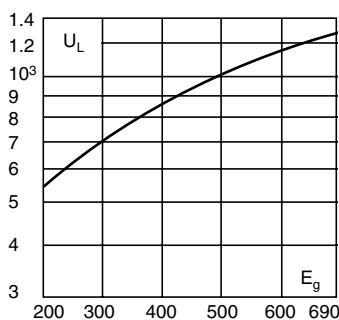

**Power Losses**

Watts loss at rated current is given in the electrical characteristics. The curve allows the calculation of the power losses at load currents lower than the rated current. The correction factor, K<sub>p</sub>, is given as a function of the RMS load current, I<sub>b</sub>, in % of the rated current.

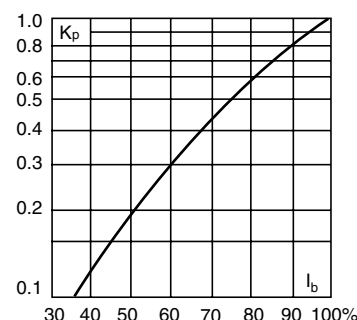

**Dimensions**

DIN 43 653: Type -KN/80, -KN/110

Size	A	B	B§	C	C§	D	E	H
1*	50	104	134	78	108	59	45	22
1	50	108	138	78	108	69	53	25
2	50	108	138	78	108	77	61	25
3	51	109	139	78	108	92	76	30

§Valid for fuse type -KN/110.

Dimension in mm.

1mm = 0.0394" 1" = 25.4mm

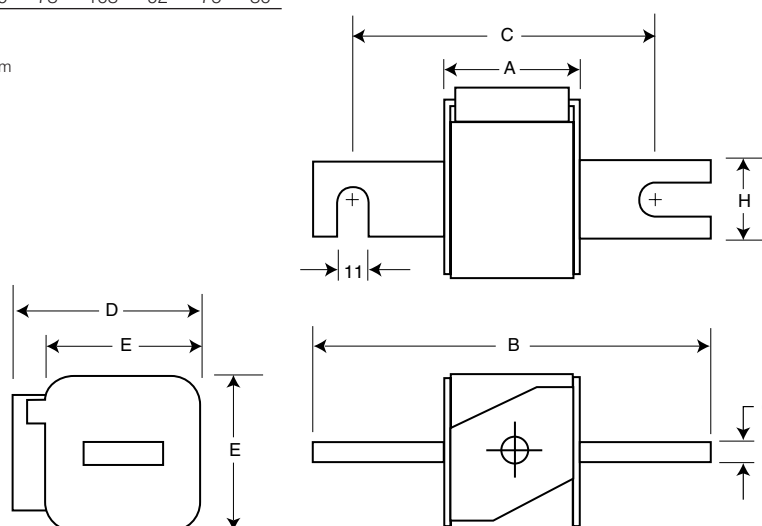



## Square Body - DIN 43 653 1000V (IEC) 20-315A

Electrical Characteristics						Ordering Information				Curves
Size	Rated Voltage	Rated Current RMS-Amps	I <sup>2</sup> t (A <sup>2</sup> s)		Watts Loss	00/80 Visual Indicator	00TN/80 Type T Indicator for Micro	Carton Qty.	Carton Weight (kg)	See Page
			Pre-arc	Clearing at Rated Voltage						
00	1000	20	20	140	5	170M4802	170M4822	6	1.45	Page 73
	1000	25	30	210	7	170M4803	170M4823			
	1000	32	55	390	9	170M4804	170M4824			
	1000	35	69	500	10	170M4805	170M4825			
	1000	40	100	690	11	170M4806	170M4826			
	1000	50	170	1200	13	170M4807	170M4827			
	1000	63	280	2000	18	170M4808	170M4828			
	1000	80	500	3500	22	170M4809	170M4829			
	1000	100	950	6850	25	170M4810	170M4830			
	1000	125	1500	11500	33	170M4811	170M4831			
	1000	160	3000	22000	37	170M4812	170M4832			
	1000	200	5600	40500	40	170M4813	170M4833			
	1000	250	10000	74000	48	170M4814	170M4834			
	900	315	18000	115000	58	170M4815	170M4835			

1 kg = 2.2 lbs. 1 lb = 0.45 kg

- Interrupting rating 150kA (Estimated 300kA) RMS Symmetrical.
- Watts loss provided at rated current.
- Microswitch ordered separately. See accessories on page 68-69.





# Square Body - DIN 43 653 1000V (IEC) 20-315A

## Electrical Characteristics

### Total clearing I<sup>2</sup>t

The total clearing I<sup>2</sup>t at rated voltage and at power factor of 15% are given in the electrical characteristics. For other voltages, the clearing I<sup>2</sup>t is found by multiplying by correction factor, K, given as a function of applied working voltage, E<sub>g</sub>, (RMS).

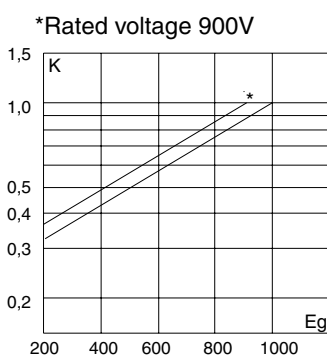

### Arc Voltage

This curve gives the peak arc voltage, U<sub>L</sub>, which may appear across the fuse during its operation as a function of the applied working voltage E<sub>g</sub>, (RMS) at a power factor of 15%.

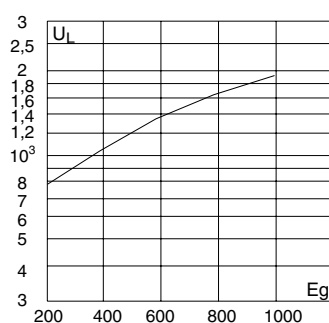

### Power Losses

Watts loss at rated current is given in the electrical characteristics. The curve allows the calculation of the power losses at load currents lower than the rated current. The correction factor, K<sub>p</sub>, is given as a function of the RMS load current, I<sub>b</sub>, in % of the rated current.

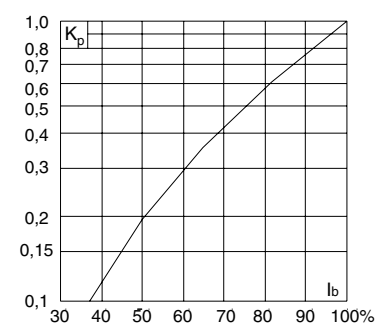

## Dimensions

DIN 43 653: Type 00TN/80 – 00/80

Size	Max A	B	C	D	Max E	F	G	H
00/80	54	98	78	51	30	28		10
00TN/80	54	98	78	51	30	28	67	10

Dimensions in mm  
1 mm = 0.0394" 1" = 25.4 mm

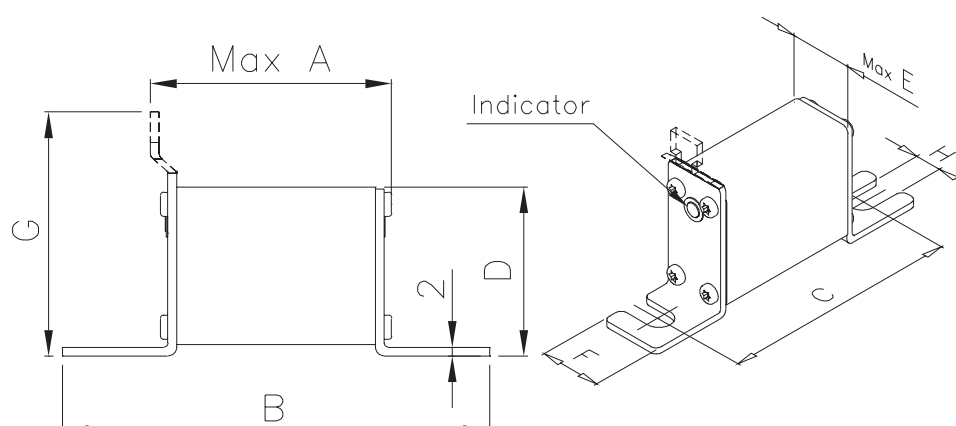



## Square Body - DIN 43 653 1000V (IEC) 50-1400A

Size	Electrical Characteristics					Ordering Information				Curves
	Rated Voltage	Rated Current RMS-Amps	I <sup>2</sup> t (A <sup>2</sup> s)		Watts Loss	-KN/110 Type K Indicator for Micro	-TN/110 Type T Indicator for Micro	Carton Qty.	Carton Weight (kg)	See Page or (Datasheet)
			Pre-arc	Clearing at Rated Voltage						
1*	1000	50	135	815	20	170M3965	170M3981	6	2.7	Page 74 or (720058)
	1000	63	215	1300	25	170M3966	170M3982			
	1000	80	460	2750	30	170M3967	170M3983			
	1000	100	860	5100	35	170M3968	170M3984			
	1000	125	1450	8600	40	170M3969	170M3985			
	1000	160	2850	17500	45	170M3970	170M3986			
	1000	200	4950	29500	48	170M3971	170M3987			
	1000	250	9550	57000	50	170M3972	170M3988			
	1000	315	21500	130000	60	170M3973	170M3989			
	1000	350	29000	175000	65	170M3974	170M3990			
	1000	400	42000	250000	70	170M3975	170M3991			
1	1000	160	2200	13500	40	170M4965	170M4980	3	2.1	Page 75 or (720059)
	1000	200	4150	24500	45	170M4966	170M4981			
	1000	250	7750	46000	52	170M4967	170M4982			
	1000	315	16500	98500	60	170M4968	170M4983			
	1000	350	21500	130000	65	170M4969	170M4984			
	1000	400	31000	185000	70	170M4970	170M4985			
	1000	450	44500	265000	80	170M4971	170M4986			
	1000	500	63000	375000	85	170M4972	170M4987			
	1000	550	84500	500000	90	170M4973	170M4988			
1000	630	125000	755000	98	170M4974	170M4989				
2	1000	250	6750	40000	65	170M5966	170M5981	3	2.7	Page 75 or (720060)
	1000	315	13500	81500	75	170M5967	170M5982			
	1000	350	16500	99000	80	170M5968	170M5983			
	1000	400	26000	155000	85	170M5969	170M5984			
	1000	450	35500	210000	90	170M5970	170M5985			
	1000	500	49500	295000	95	170M5971	170M5986			
	1000	550	66000	390000	100	170M5972	170M5987			
	1000	630	93500	555000	110	170M5973	170M5988			
	1000	700	130000	770000	115	170M5974	170M5989			
	1000	800	195000	1200000	125	170M5975	170M5990			
3	1000	315	9200	54500	90	170M8614	170M8629	1	1.5	Page 76 or (720061)
	1000	350	13000	77500	95	170M8615	170M8630			
	1000	400	19000	115000	105	170M8616	170M8631			
	1000	450	27000	160000	107	170M8617	170M8632			
	1000	500	37500	225000	110	170M8618	170M8633			
	1000	550	52000	310000	115	170M8619	170M8634			
	1000	630	82500	490000	120	170M8620	170M8635			
	1000	700	115000	700000	125	170M8621	170M8636			
	1000	800	170000	1050000	135	170M8622	170M8637			
	1000	900	250000	1500000	145	170M8623	170M8638			
	1000	1000	340000	2050000	150	170M8624	170M8639			
	1000	1100	460000	2750000	155	170M8625	170M8640			
	1000	1250	575000	3400000	175	170M8626	170M8641			
	900	1400	795000	4200000	185	170M8627	170M8642			

1 kg = 2.2 lbs. 1 lb = 0.45 kg

- Interrupting rating 150kA (Estimated 300kA) RMS Symmetrical.
- Watts loss provided at rated current.
- Microswitch ordered separately. See accessories on page 68-69.







# Square Body - DIN 43 653 1000V (IEC) 50-1400A

## Electrical Characteristics

### Total clearing I<sup>2</sup>t

The total clearing I<sup>2</sup>t at rated voltage and at power factor of 15% are given in the electrical characteristics. For other voltages, the clearing I<sup>2</sup>t is found by multiplying by correction factor, K, given as a function of applied working voltage, E<sub>g</sub>, (RMS).

\*Rated voltage 900V

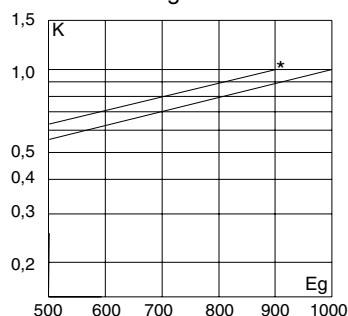

### Arc Voltage

This curve gives the peak arc voltage, U<sub>L</sub>, which may appear across the fuse during its operation as a function of the applied working voltage E<sub>g</sub>, (RMS) at a power factor of 15%.

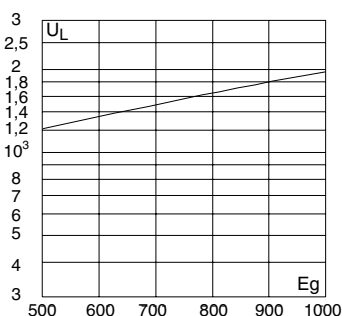

### Power Losses

Watts loss at rated current is given in the electrical characteristics. The curve allows the calculation of the power losses at load currents lower than the rated current. The correction factor, K<sub>p</sub>, is given as a function of the RMS load current, I<sub>b</sub>, in % of the rated current.

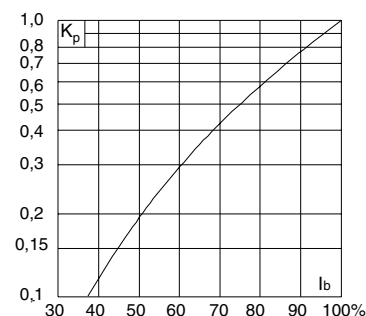

## Dimensions

DIN 43 653 Type -KN/110 and -TN/110

Size	A	B	C	Max D1	E	G	H	I
1*KN/110	80	138	108	61	43	6	22	11
1KN/110	80	138	108	69	51	6	25	11
2KN/110	80	138	108	77	59	6	25	11
3KN/110	81	139	108	92	74	6	30	11

Size	A	B	C	Max D2	E	G	H	I
1*TN/110	80	138	108	61	43	6	22	11
1TN/110	80	138	108	69	51	6	25	11
2TN/110	80	138	108	75	59	6	25	11
3TN/110	81	139	108	90	74	6	30	11

Dimensions in mm  
1 mm = 0.0394" 1" = 25.4 mm

### KN/110

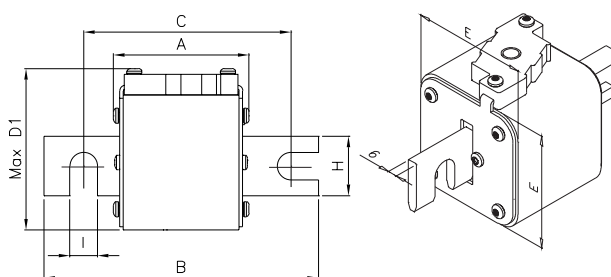

### TN/110

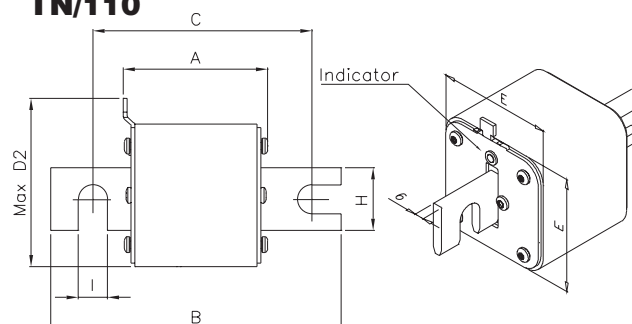



# Square Body - DIN 43 653 1250V/1300V (IEC/U.L.) 50-1400A



Electrical Characteristics						Ordering Information				Curves
Size	Rated Current RMS-Amps	I <sup>2</sup> t (A <sup>2</sup> S)			Watts Loss	-/110 Visual Indicator	-TN/110 Type T Indicator for Micro	Carton Qty.	Carton Weight (kg)	See Page or (Datasheet)
		Pre-arc	Clearing at 1000V	Clearing at 1250V						
1*	50	135	815	1100	15	170M3138	170M3188	5	1.90	page 76 (720062)
	63	215	1300	1750	20	170M3139	170M3189			
	80	420	2500	3350	25	170M3140	170M3190			
	100	750	4450	5950	30	170M3141	170M3191			
	125	1450	9000	11500	35	170M3142	170M3192			
	160	2600	16000	21000	40	170M3143	170M3193			
	200	5150	31000	41000	45	170M3144	170M3194			
	250	9200	54500	73000	55	170M3145	170M3195			
	315	18500	115000	150000	60	170M3146	170M3196			
	350	27000	165000	220000	65	170M3147	170M3197			
	400	53000	265000	335000	70	170M3148	170M3198			
1	160	1900	11500	15500	45	170M4138	170M4188	2	1.18	page 77 (720063)
	200	3800	22500	30000	50	170M4139	170M4189			
	250	7750	46000	61500	60	170M4140	170M4190			
	315	15000	90000	120000	65	170M4141	170M4191			
	350	20000	125000	165000	70	170M4142	170M4192			
	400	29500	175000	235000	75	170M4143	170M4193			
	450	42000	250000	335000	80	170M4144	170M4194			
	500	69500	340000	435000	85	170M4145	170M4195			
	550	95000	465000	590000	95	170M4146	170M4196			
	†630	130000	660000		100	170M4147	170M4197			
	2	250	6500	38500	51500	65	170M5138			
280		9350	55500	74500	70	170M5139	170M5189			
315		13000	77500	105000	75	170M5140	170M5190			
350		16500	97500	135000	80	170M5141	170M5191			
400		23000	140000	180000	85	170M5142	170M5192			
450		34000	205000	270000	90	170M5143	170M5193			
500		48000	285000	380000	95	170M5144	170M5194			
550		62000	370000	495000	100	170M5145	170M5195			
630		115000	575000	730000	110	170M5146	170M5196			
700		160000	795000	1050000	115	170M5147	170M5197			
800		245000	1200000	1550000	120	170M5148	170M5198			
†900		360000	1750000		125	170M5149	170M5199			
†1000		480000	2350000		135	170M5150	170M5200			
3		315	9500	58000	77500	85	170M6138	170M6188	1	1.23
	350	13500	81500	110000	90	170M6139	170M6189			
	400	19500	120000	160000	95	170M6140	170M6190			
	450	31000	185000	245000	100	170M6141	170M6191			
	500	39000	235000	310000	105	170M6142	170M6192			
	550	55000	325000	435000	110	170M6143	170M6193			
	630	83500	495000	665000	115	170M6144	170M6194			
	700	115000	705000	940000	120	170M6145	170M6195			
	†800	205000	995000	1300000	125	170M6146	170M6196			
	†900	305000	1500000	1900000	130	170M6147	170M6197			
	†1000	450000	2150000	2750000	135	170M6148	170M6198			
	†1100	575000	2800000	3600000	140	170M6149	170M6199			
	†1250	810000	3950000		145	170M6150	170M6200			
	†1400	1250000	6000000		150	170M6151	170M6201			

- Interrupting rating 100kA RMS Symmetrical.
- Watts loss provided at rated current.
- Rated voltage (IEC) †1100V †1250V (Consult Bussmann for U.L. Recognition/ CSA Component Acceptance status.)
- Microswitch indicator ordered separately. See accessories on pages 68-69.

1 kg = 2.2 lbs. 1 lb = 0.45 kg





**Square Body - DIN 43 653**

**1250V/1300V (IEC/U.L.) 50-1400A**



**Electrical Characteristics**

**Total Clearing I<sup>2</sup>t**

The total clearing I<sup>2</sup>t at rated voltage and at power factor of 15% are given in the electrical characteristics. For other voltages, the clearing I<sup>2</sup>t is found by multiplying by correction factor, K, given as a function of applied working voltage, E<sub>g</sub>, (RMS).

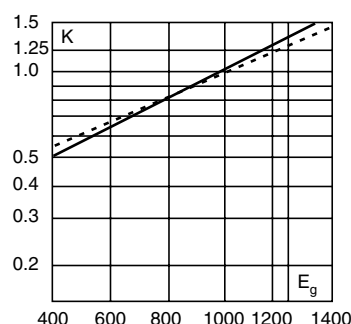

**Arc Voltage**

This curve gives the peak arc voltage, U<sub>L</sub>, which may appear across the fuse during its operation as a function of the applied working voltage, E<sub>g</sub>, (RMS) at a power factor of 15%.

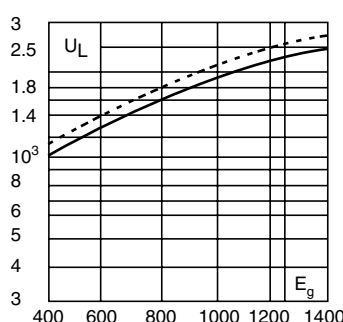

**Power Losses**

Watts loss at rated current is given in the electrical characteristics. The curve allows the calculation of the power losses at load currents lower than the rated current. The correction factor, K<sub>p</sub>, is given as a function of the RMS load current, I<sub>b</sub>, in % of the rated current.

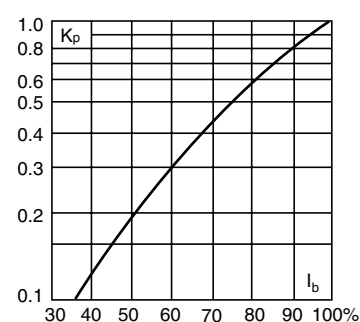

Dashed lines apply to the following amperages:

Size	1*	1	2	3
Amp	400	500-630	630-1000	800-1400

**Dimensions**

DIN 43 653: Type -/110, -TN/110

Size	A	B	D	E	H
1*	80	138	58	45	20
1	80	138	66	53	25
2	80	138	75	61	25
3	81	139	90	76	30

Dimension in mm.  
1mm = 0.0394" 1" = 25.4mm

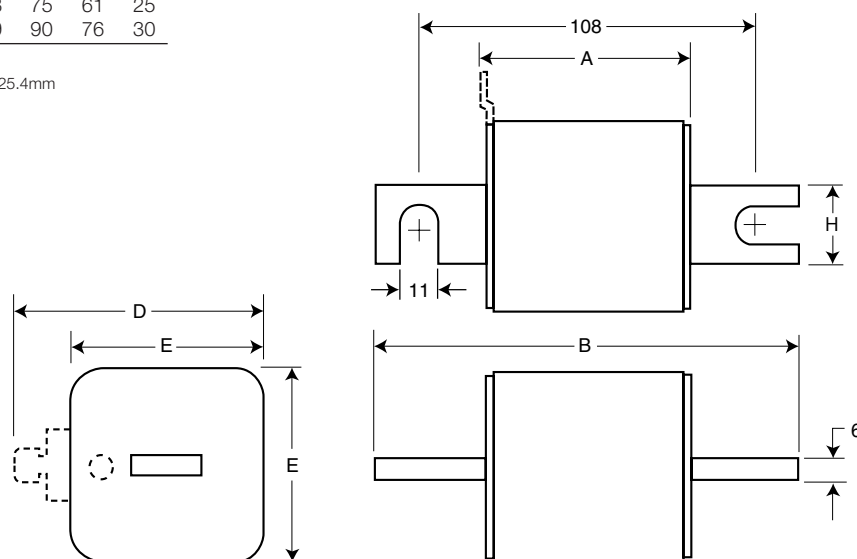



# Square Body - DIN 43 653 1250V/1300V (IEC/U.L.) 50-1400A



Electrical Characteristics						Ordering Information		Curves	
Size	Rated Current RMS-Amps	I <sup>2</sup> t (A <sup>2</sup> S)			Watts Loss	-KN/110 Type K Visual Indicator for Micro	Carton Qty.	Carton Weight (kg)	See Page or (Datasheet)
		Pre-arc	Clearing at 1000V	Clearing at 1250V					
1*	50	135	815	1100	15	170M3238	2	0.84	page 76 (720066)
	63	215	1300	1750	20	170M3239			
	80	420	2500	3350	25	170M3240			
	100	750	4450	5950	30	170M3241			
	125	1450	9000	11500	35	170M3242			
	160	2600	16000	21000	40	170M3243			
	200	5150	31000	41000	45	170M3244			
	250	9200	54500	73000	55	170M3245			
	315	18500	115000	150000	60	170M3246			
	350	27000	165000	220000	65	170M3247			
	400	53000	265000	335000	70	170M3248			
1	160	1900	11500	15500	45	170M4238	2	1.26	page 77 (720067)
	200	3800	22500	30000	50	170M4239			
	250	7750	46000	61500	60	170M4240			
	315	15000	90000	120000	65	170M4241			
	350	20000	125000	165000	70	170M4242			
	400	29500	175000	235000	75	170M4243			
	450	42000	250000	335000	80	170M4244			
	500	69500	340000	435000	85	170M4245			
	550	95000	465000	590000	95	170M4246			
	†630	130000	660000		100	170M4247			
	2	250	6500	38500	51500	65			
280		9350	55500	74500	70	170M5239			
315		13000	77500	105000	75	170M5240			
350		16500	97500	135000	80	170M5241			
400		23000	140000	180000	85	170M5242			
450		34000	205000	270000	90	170M5243			
500		48000	285000	380000	95	170M5244			
550		62000	370000	495000	100	170M5245			
630		115000	575000	730000	110	170M5246			
700		160000	795000	1050000	115	170M5247			
800		245000	1200000	1550000	120	170M5248			
†900		360000	1750000		125	170M5249			
†1000		480000	2350000		135	170M5250			
3	315	9500	58000	77500	85	170M6238	1	1.27	page 78 (720069)
	350	13500	81500	110000	90	170M6239			
	400	19500	120000	160000	95	170M6240			
	450	31000	185000	245000	100	170M6241			
	500	39000	235000	310000	105	170M6242			
	550	55000	325000	435000	110	170M6243			
	630	83500	495000	665000	115	170M6244			
	700	115000	705000	940000	120	170M6245			
	†800	205000	995000	1300000	125	170M6246			
	†900	305000	1500000	1900000	130	170M6247			
	†1000	450000	2150000	2750000	135	170M6248			
	†1100	575000	2800000	3600000	140	170M6249			
	†1250	810000	3950000		145	170M6250			
	†1400	1250000	6000000		150	170M6251			

- Interrupting rating 100kA RMS Symmetrical.
- Watts loss provided at rated current.
- Rated voltage (IEC) †1100V †1250V (Consult Bussmann for U.L. Recognition/ CSA Component Acceptance status.)
- Microswitch indicator ordered separately. See accessories on pages 68-69.

1 kg = 2.2 lbs. 1 lb = 0.45 kg





**Square Body - DIN 43 653**

**1250V/1300V (IEC/U.L.) 50-1400A**



**Electrical Characteristics**

**Total Clearing I<sup>2</sup>t**

The total clearing I<sup>2</sup>t at rated voltage and at power factor of 15% are given in the electrical characteristics. For other voltages, the clearing I<sup>2</sup>t is found by multiplying by correction factor, K, given as a function of applied working voltage, E<sub>g</sub>, (RMS).

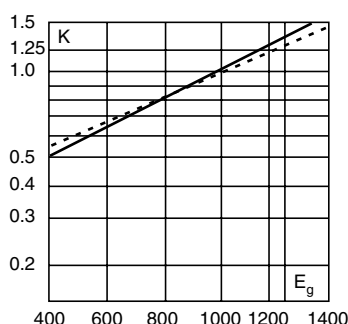

**Arc Voltage**

This curve gives the peak arc voltage, U<sub>L</sub>, which may appear across the fuse during its operation as a function of the applied working voltage, E<sub>g</sub>, (RMS) at a power factor of 15%.

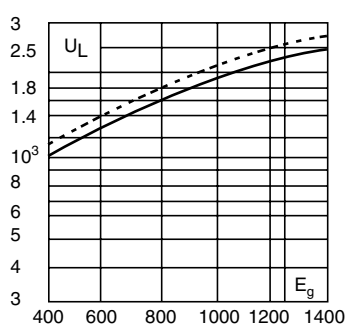

**Power Losses**

Watts loss at rated current is given in the electrical characteristics. The curve allows the calculation of the power losses at load currents lower than the rated current. The correction factor, K<sub>p</sub>, is given as a function of the RMS load current, I<sub>b</sub>, in % of the rated current.

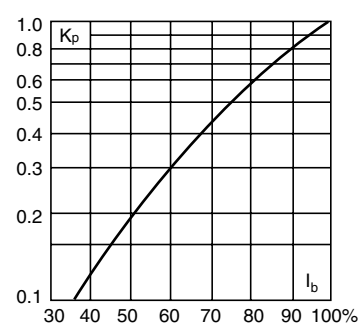

-----  
Dashed lines apply to the following amperages:

Size	1*	1	2	3
Amp	400	500-630	630-1000	800-1400

**Dimensions**

DIN 43 653: Type -KN/110

Size	A	B	D	E	H
1*	80	138	59	45	20
1	80	138	69	53	25
2	80	138	77	61	25
3	81	139	92	76	30

Dimension in mm.  
1mm = 0.0394" 1" = 25.4mm

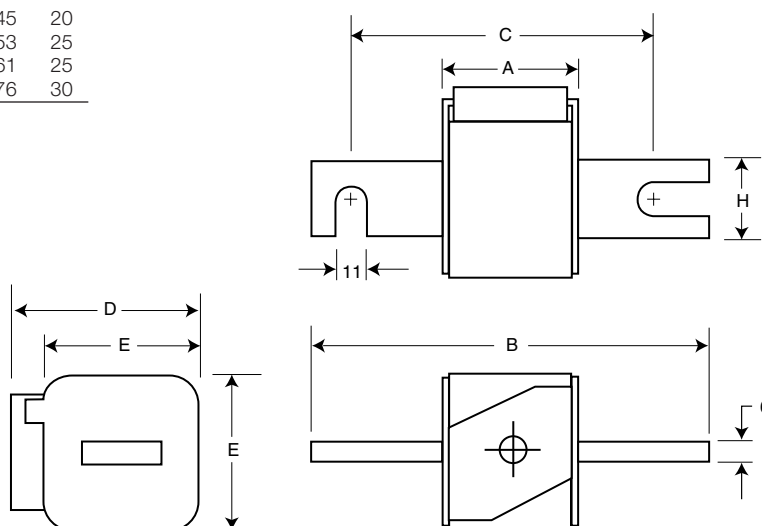



# Square Body - DIN 43 620 690V (IEC/U.L.) 10-315A



Size	Rated Current RMS-Amps	Electrical Characteristics		Watts Loss	Ordering Information		Curves	
		I <sup>2</sup> t (A <sup>2</sup> S)			DIN 000 Type T Indicator for Micro	Carton Qty.		Carton Weight (kg)
		Pre-arc	Clearing at 660V					
000	10	3.8	25.5	3.0	170M1558	10	1.30	page 70
	16	7.2	48	5.5	170M1559			
	20	11.5	78	7	170M1560			
	25	19	130	9	170M1561			
	32	40	270	10	170M1562			
	40	69	460	12	170M1563			
	50	115	770	15	170M1564			
	63	215	1450	16	170M1565			
	80	380	2550	19	170M1566			
	100	695	4650	24	170M1567			
	125	1200	8500	28	170M1568			
	160	2300	16000	32	170M1569			
	200	4200	28000	37	170M1570			
	250	7750	51500	42	170M1571			
315	12000	80500	52	170M1572				

- Interrupting rating 200kA (Estimated 300kA) RMS Symmetrical.
- Watts loss provided at rated current.
- Microswitch indicator ordered separately. See accessories on pages 68-69.

1 kg = 2.2 lbs. 1 lb = 0.45 kg

### Rated Current

The rated current of this fuse range has been given with copper conductors that have a current density of 1.3 A/mm<sup>2</sup> (IEC 60269-4). For conductor cross section according to IEC 60269-1, the fuses with a rated current higher than 125A must be derated. Please contact Bussmann for application assistance.





Square Body – DIN 43 620

**690V (IEC/U.L.) 10-315A**



### Electrical Characteristics

#### Total Clearing I<sup>2</sup>t

The total clearing I<sup>2</sup>t at rated voltage and at power factor of 15% are given in the electrical characteristics. For other voltages, the clearing I<sup>2</sup>t is found by multiplying by correction factor, K, given as a function of applied working voltage, E<sub>g</sub>, (RMS).

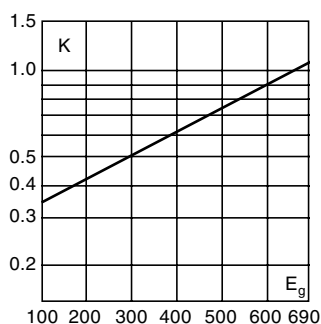

#### Arc Voltage

This curve gives the peak arc voltage, U<sub>L</sub>, which may appear across the fuse during its operation as a function of the applied working voltage, E<sub>g</sub>, (RMS) at a power factor of 15%.

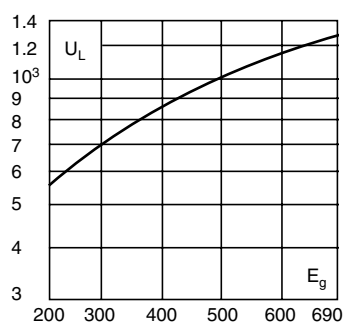

#### Power Losses

Watts loss at rated current is given in the electrical characteristics. The curve allows the calculation of the power losses at load currents lower than the rated current. The correction factor, K<sub>p</sub>, is given as a function of the RMS load current, I<sub>b</sub>, in % of the rated current.

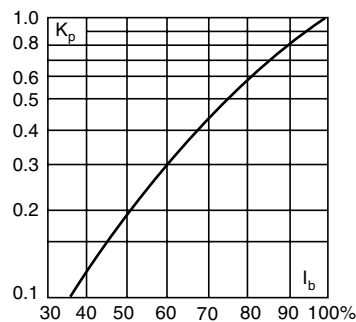

### Dimensions

DIN 43 620: Type DIN 000

Dimension in mm.  
1mm = 0.0394" 1" = 25.4mm

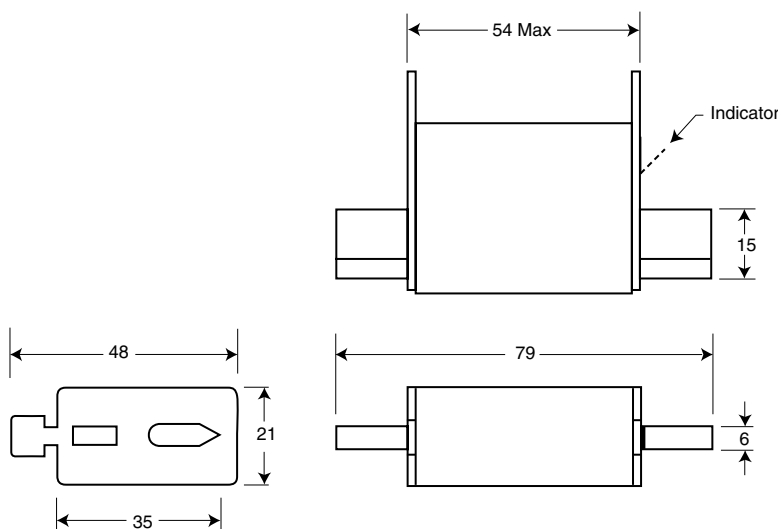





# Square Body - DIN 43 620 690V/700V (IEC/U.L.) 40-1000A



Size	Electrical Characteristics				Ordering Information			Curves
	Rated Current RMS-Amps	I <sup>2</sup> t (A <sup>2</sup> S)		Watts Loss	DIN Type T Indicator for Micro	Carton Qty.	Carton Weight (kg)	See Page or (Datasheet)
		Pre-arc	Clearing at 660V					
1*	40	40	270	9	170M3808	5	1.85	page 71 (720070)
	50	77	515	11	170M3809			
	63	115	770	14	170M3810			
	80	185	1250	18	170M3811			
	100	360	2450	21	170M3812			
	125	550	3700	26	170M3813			
	160	1100	7500	30	170M3814			
	200	2200	15000	35	170M3815			
	250	4200	28500	40	170M3816			
	315	7000	46500	50	170M3817			
350	10000	68500	55	170M3818				
400	15000	105000	60	170M3819				
2	400	11000	74000	65	170M5808	5	3.00	page 72 (720071)
	450	15500	105000	70	170M5809			
	500	21500	145000	75	170M5810			
	550	28000	190000	80	170M5811			
	630	41000	275000	90	170M5812			
	700	60500	405000	95	170M5813			
3	500	14000	95000	95	170M6808	1	1.15	page 72 (720072)
	550	19500	135000	100	170M6809			
	630	31000	210000	105	170M6810			
	700	44500	300000	110	170M6811			
	800	69500	465000	115	170M6812			
	900	100000	670000	120	170M6813			
	1000	140000	945000	125	170M6814			

- Interrupting rating 200kA (Estimated 300kA) RMS Symmetrical.
- Watts loss provided at rated current.
- Microswitch indicator ordered separately. See accessories on pages 68-69.

1 kg = 2.2 lbs. 1 lb = 0.45 kg

### Rated Current

The rated current of this fuse range has been given with copper conductors that have a current density of 1.3 A/mm<sup>2</sup> (IEC 60269-4). For conductor cross section according to IEC 60269-1, the fuses must be derated. Please contact Bussmann for application assistance.





**Square Body – DIN 43 620**

**690V/700V (IEC/U.L.) 40-1000A**



**Electrical Characteristics**

**Total Clearing I<sup>2</sup>t**

The total clearing I<sup>2</sup>t at rated voltage and at power factor of 15% are given in the electrical characteristics. For other voltages, the clearing I<sup>2</sup>t is found by multiplying by correction factor, K, given as a function of applied working voltage, E<sub>g</sub>, (RMS).

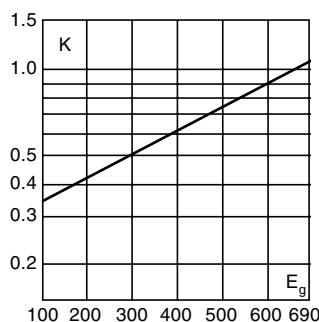

**Arc Voltage**

This curve gives the peak arc voltage, U<sub>L</sub>, which may appear across the fuse during its operation as a function of the applied working voltage, E<sub>g</sub>, (RMS) at a power factor of 15%.

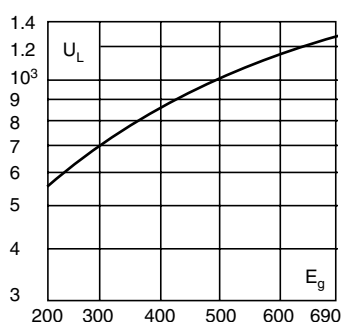

**Power Losses**

Watts loss at rated current is given in the electrical characteristics. The curve allows the calculation of the power losses at load currents lower than the rated current. The correction factor, K<sub>p</sub>, is given as a function of the RMS load current, I<sub>b</sub>, in % of the rated current.

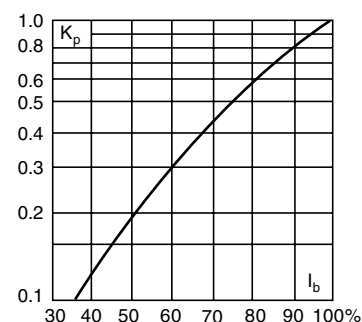

**Dimensions**

DIN 43 620: Type DIN 1\*, DIN 2, DIN 3

Size	A	B	D	E	F	H
1*	69	135	58	45	40	20
2	69	150	71	55	48	26
3	68	150	88	76	60	33

Dimension in mm.  
1mm = 0.0394" 1" = 25.4mm

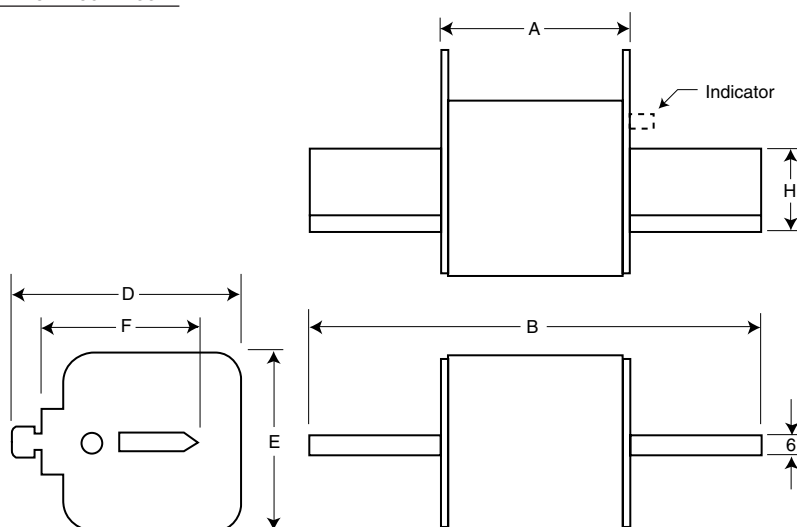

This bulletin is intended to clearly present comprehensive product data and provide technical information that will help the end user with design applications. Bussmann reserves the right, without notice, to change design or construction of any products and to discontinue or limit distribution of any products. Bussmann also reserves the right to change or update, without notice, any technical information contained in this bulletin. Once a product has been selected, it should be tested by the user in all possible applications.





## Square Body - DIN 43 620 1000V (IEC) 20-225A

Electrical Characteristics						Ordering Information			Curves
Size	Rated Voltage	Rated Current RMS-Amps	I <sup>2</sup> t (A <sup>2</sup> s)		Watts Loss	Type T Indicator for Micro	Carton Qty.	Carton Weight (kg)	See Page
			Pre-arc	Clearing at Rated Voltage					
00	1000	20	15	110	8.5	170M2673	6	1.3	Page 74
	1000	25	28.5	210	9.5	170M2674			
	1000	32	53	390	11	170M2675			
	1000	35	69	500	12	170M2676			
	1000	40	105	760	13	170M2677			
	1000	50	215	1550	14	170M2678			
	1000	63	380	2750	16	170M2679			
	1000	80	815	5900	18	170M2680			
	1000	100	1550	11500	21	170M2681			
	1000	125	3000	22000	23	170M2682			
	1000	160	6250	45000	26	170M2683			
	900	200	12000	86500	31	170M2684			
	900	225	18000	115000	33	170M2685			

1 kg = 2.2 lbs. 1 lb = 0.45 kg

- Interrupting rating 150kA (Estimated 300kA) RMS Symmetrical.
- Watts loss provided at rated current.
- Microswitch indicator ordered separately. See accessories on page 68-69.

### Rated Current

The rated current of this fuse range is given with open fuse bases connected to copper conductors according to IEC 60269 Part 1, table 10.

When used in enclosed fuse bases/disconnects, derating factors have to be observed.

Please contact Bussmann for application assistance.





# Square Body - DIN 43 620 1000V (IEC) 20-225A

## Electrical Characteristics

### Total clearing I<sup>2</sup>t

The total clearing I<sup>2</sup>t at rated voltage and at power factor of 15% are given in the electrical characteristics. For other voltages, the clearing I<sup>2</sup>t is found by multiplying by correction factor, K, given as a function of applied working voltage, E<sub>g</sub>, (RMS).

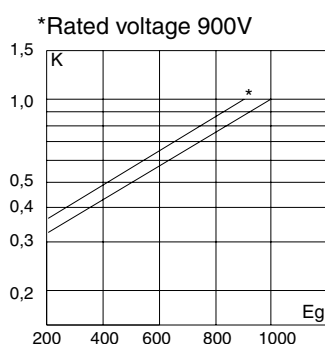

### Arc Voltage

This curve gives the peak arc voltage, U<sub>L</sub>, which may appear across the fuse during its operation as a function of the applied working voltage E<sub>g</sub>, (RMS) at a power factor of 15%.

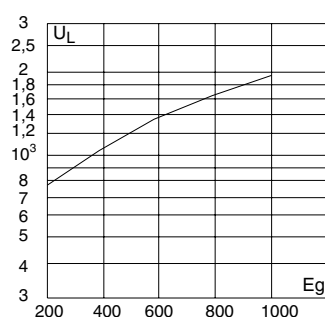

### Power Losses

Watts loss at rated current is given in the electrical characteristics. The curve allows the calculation of the power losses at load currents lower than the rated current. The correction factor, K<sub>p</sub>, is given as a function of the RMS load current, I<sub>b</sub>, in % of the rated current.

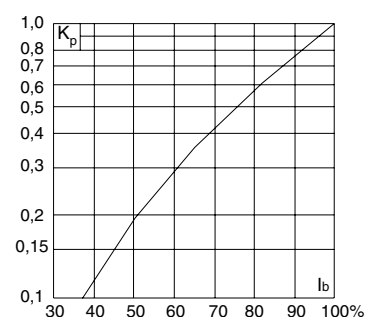

## Dimensions

DIN 43 620: Type DIN 00

Size	A	B	Max D	Max E	F	G	Min H
DIN 00	49	78,5	60	30	35	6	15

Dimensions in mm  
1 mm = 0.0394" 1" = 25.4 mm

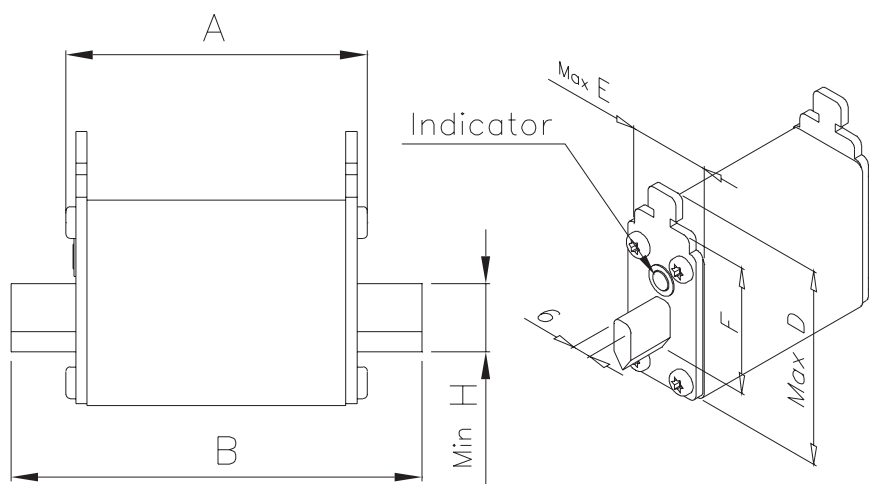



## Square Body - Flush End Contact 690V (IEC) 25-400A

Electrical Characteristics					Ordering Information			Curves	
Size	Rated Current RMS-Amps	I <sup>2</sup> t (A <sup>2</sup> S)		Watts Loss	00B/60 Visual Indicator	00BTN/60 Type T Indicator for Micro	Carton Qty.	Carton Weight (kg)	See Page
		Pre-arc	Clearing at 660V						
00	25	19	130	6	170M2708	170M2758	5	1.35	page 70
	32	28.5	195	7	170M2709	170M2759			
	40	50	360	9	170M2710	170M2760			
	50	95	640	10	170M2711	170M2761			
	63	170	1200	12	170M2712	170M2762			
	80	310	2100	15	170M2713	170M2763			
	100	620	4150	20	170M2714	170M2764			
	125	1000	6950	25	170M2715	170M2765			
	160	1900	13000	30	170M2716	170M2766			
	200	3400	23000	35	170M2717	170M2767			
	250	6250	42000	45	170M2718	170M2768			
	315	10000	68500	55	170M2719	170M2769			
	350	13500	91500	60	170M2720	170M2770			
	400	18000	125000	70	170M2721	170M2771			

- Interrupting rating 200kA (Estimated 300kA) RMS Symmetrical.
- Watts loss provided at rated current.
- Microswitch indicator ordered separately. See accessories on pages 68-69.

1 kg = 2.2 lbs. 1 lb = 0.45 kg





# Square Body - Flush End Contact 690V (IEC) 25-400A

## Electrical Characteristics

### Total Clearing I<sup>2</sup>t

The total clearing I<sup>2</sup>t at rated voltage and at power factor of 15% are given in the electrical characteristics. For other voltages, the clearing I<sup>2</sup>t is found by multiplying by correction factor, K, given as a function of applied working voltage, E<sub>g</sub>, (RMS).

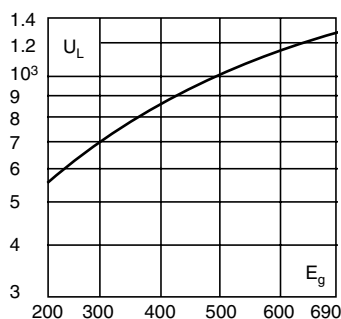

### Arc Voltage

This curve gives the peak arc voltage, U<sub>L</sub>, which may appear across the fuse during its operation as a function of the applied working voltage, E<sub>g</sub>, (RMS) at a power factor of 15%.

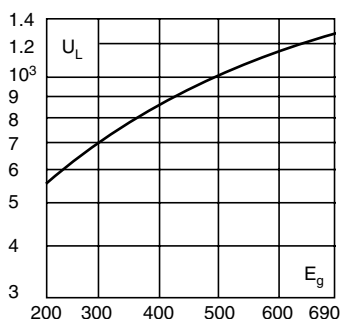

### Power Losses

Watts loss at rated current is given in the electrical characteristics. The curve allows the calculation of the power losses at load currents lower than the rated current. The correction factor, K<sub>p</sub>, is given as a function of the RMS load current, I<sub>b</sub>, in % of the rated current.

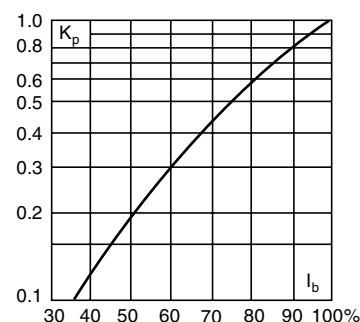

## Dimensions

Flush End Contact: Type 00B/60, 00BTN/60

Dimension in mm.  
1mm = 0.0394" 1" = 25.4mm

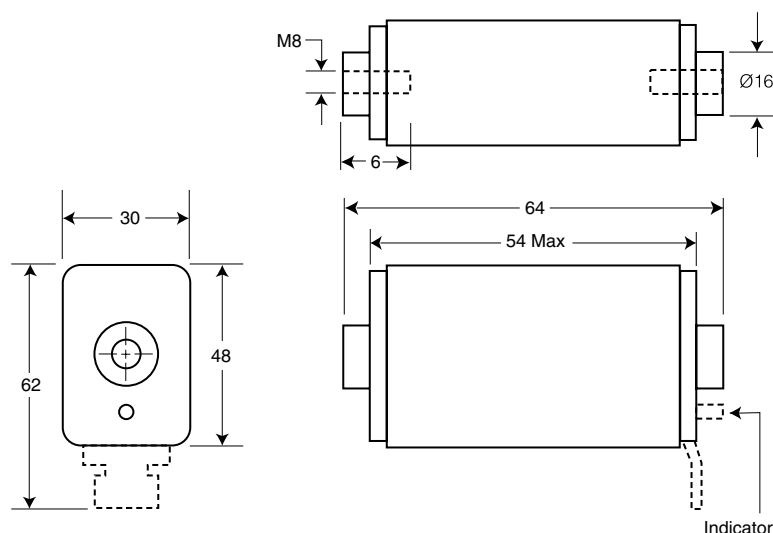



# Square Body - Flush End Contact 690V/700V (IEC/U.L.) 40-2000A



Electrical Characteristics				Ordering Information					Curves		
Size	Rated Current RMS-Amps	I <sup>2</sup> t (A <sup>2</sup> S)		Losses at Rated Current	-B/- Visual Indicator	-BKN/- Type K Indicator for Micro	-G/- Visual Indicator	-GKN/- Type K Indicator for Micro	Carton Qty.	Carton Weight (kg)	See Page or (Datasheet)
		Pre-arc	Clearing at 660V								
1*	40	40	270	9	170M3408	170M3458	170M3508	170M3558	10 (-B/-)	2.40	page 71 (720073)
	50	77	515	11	170M3409	170M3459	170M3509	170M3559			
	63	115	770	14	170M3410	170M3460	170M3510	170M3560			
	80	185	1250	18	170M3411	170M3461	170M3511	170M3561			
	100	360	2450	21	170M3412	170M3462	170M3512	170M3562	10 (-G/-)	2.40	
	125	550	3700	26	170M3413	170M3463	170M3513	170M3563			
	160	1100	7500	30	170M3414	170M3464	170M3514	170M3564			
	200	2200	15000	35	170M3415	170M3465	170M3515	170M3565			
	250	4200	28500	40	170M3416	170M3466	170M3516	170M3566	6 (-BKN/-)	1.62	
	315	7000	46500	50	170M3417	170M3467	170M3517	170M3567			
	350	10000	68500	55	170M3418	170M3468	170M3518	170M3568			
	400	15000	105000	60	170M3419	170M3469	170M3519	170M3569			
	450	21000	140000	65	170M3420	170M3470	170M3520	170M3570	6 (-GKN/-)	1.62	
	500	27000	180000	70	170M3421	170M3471	170M3521	170M3571			
550	34000	230000	75	170M3422	170M3472	170M3522	170M3572				
630	48500	325000	80	170M3423	170M3473	170M3523	170M3573				
1	200	1650	11500	45	170M4408	170M4458	170M4508	170M4558	6	2.40	page 71 (720074)
	250	3100	21000	55	170M4409	170M4459	170M4509	170M4559			
	315	6200	42000	58	170M4410	170M4460	170M4510	170M4560			
	350	8500	59000	60	170M4411	170M4461	170M4511	170M4561			
	400	13500	91500	65	170M4412	170M4462	170M4512	170M4562			
	450	17000	120000	70	170M4413	170M4463	170M4513	170M4563			
	500	25000	170000	72	170M4414	170M4464	170M4514	170M4564			
	550	34000	230000	75	170M4415	170M4465	170M4515	170M4565			
	630	52000	350000	80	170M4416	170M4466	170M4516	170M4566			
	700	69500	465000	85	170M4417	170M4467	170M4517	170M4567			
	800	105000	725000	95	170M4418	170M4468	170M4518	170M4568			
†900	155000	†850000	100	170M4419	170M4469	170M4519	170M4569				
2	400	11000	74000	65	170M5408	170M5458	170M5508	170M5558	6	3.30	page 72 (720075)
	450	15500	105000	70	170M5409	170M5459	170M5509	170M5559			
	500	21500	145000	75	170M5410	170M5460	170M5510	170M5560			
	550	28000	190000	80	170M5411	170M5461	170M5511	170M5561			
	630	41000	275000	90	170M5412	170M5462	170M5512	170M5562			
	700	60500	405000	95	170M5413	170M5463	170M5513	170M5563			
	800	86000	575000	105	170M5414	170M5464	170M5514	170M5564			
	900	125000	840000	110	170M5415	170M5465	170M5515	170M5565			
	1000	180000	1250000	115	170M5416	170M5466	170M5516	170M5566			
	1100	245000	1600000	120	170M5417	170M5467	170M5517	170M5567			
	1250	365000	2400000	130	170M5418	170M5468	170M5518	170M5568			
3	500	14000	95000	95	170M6408	170M6458	170M6508	170M6558	3	2.52	page 72 (720076)
	550	19500	135000	100	170M6409	170M6459	170M6509	170M6559			
	630	31000	210000	105	170M6410	170M6460	170M6510	170M6560			
	700	44500	300000	110	170M6411	170M6461	170M6511	170M6561			
	800	69500	465000	115	170M6412	170M6462	170M6512	170M6562			
	900	100000	670000	120	170M6413	170M6463	170M6513	170M6563			
	1000	140000	945000	125	170M6414	170M6464	170M6514	170M6564			
	1100	190000	1300000	130	170M6415	170M6465	170M6515	170M6565			
	1250	290000	1950000	140	170M6416	170M6466	170M6516	170M6566			
	1400	370000	2450000	155	170M6417	170M6467	170M6517	170M6567			
	1500	460000	3100000	160	170M6418	170M6468	170M6518	170M6568			
	1600	580000	3900000	160	170M6419	170M6469	170M6519	170M6569			
	†1800	880000	†5250000	165	170M6420	170M6470	170M6520	170M6570			
	†2000	1150000	†6350000	175	170M6421	170M6471	170M6521	170M6571			

- Interrupting rating 200kA (Estimated 300kA) RMS Symmetrical.
- Watts loss provided at rated current.
- Rated voltage (IEC) †600V †550V (Consult Bussmann for U.L. Recognition / CSA Component Acceptance Status.)
- Microswitch indicator ordered separately. See accessories on pages 68-69.

1 kg = 2.2 lbs. 1 lb = 0.45 kg







**Square Body – Flush End Contact**

**690V/700V (IEC/U.L.) 40-2000A**



**Electrical Characteristics**

**Total Clearing I<sup>2</sup>t**

The total clearing I<sup>2</sup>t at rated voltage and at power factor of 15% are given in the electrical characteristics. For other voltages, the clearing I<sup>2</sup>t is found by multiplying by correction factor, K, given as a function of applied working voltage, E<sub>g</sub>, (RMS).

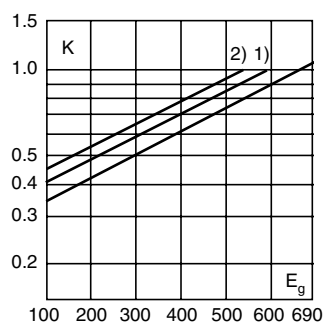

1) Rated voltage 600V  
2) Rated voltage 550V

**Arc Voltage**

This curve gives the peak arc voltage, U<sub>L</sub>, which may appear across the fuse during its operation as a function of the applied working voltage, E<sub>g</sub>, (RMS) at a power factor of 15%.

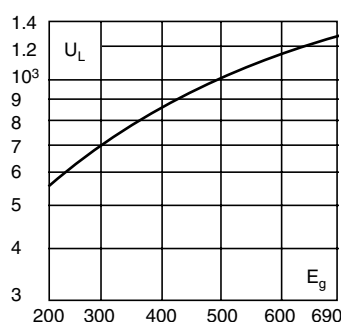

**Power Losses**

Watts loss at rated current is given in the electrical characteristics. The curve allows the calculation of the power losses at load currents lower than the rated current. The correction factor, K<sub>p</sub>, is given as a function of the RMS load current, I<sub>b</sub>, in % of the rated current.

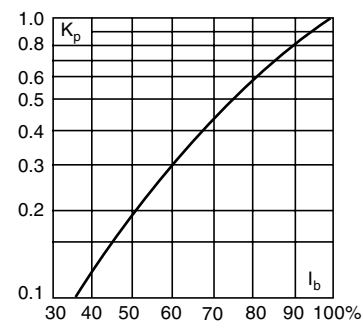

**Dimensions**

Flush End Contact: Type -B/-, -BKN/-, -G/-, -GKN/-

Size	A	B	D	E	F	F <sup>§</sup>	G	H
1*	50	51	59	45	M8	5/16" - 18 UNC-2B	5	ø17
1	50	51	69	53	M8	5/16" - 18 UNC-2B	8	ø20
2	50	51	77	61	M10	3/8" - 16 UNC-2B	10	ø24
3	51	53	92	76	M12	1/2" - 13 UNC-2B	10	ø30

<sup>§</sup>Valid for fuses type -G/- & -GKN/-

NB: B = 65 for Size 2, 1100-1250A  
Size 3, 1600-2000A

Carton Quantity = 4 Carton Weight = 2.40 kg  
Carton Quantity = 2 Carton Weight = 1.82 kg

Dimension in mm.

1mm = 0.0394" 1" = 25.4mm

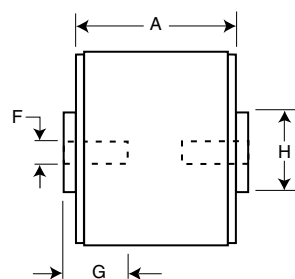
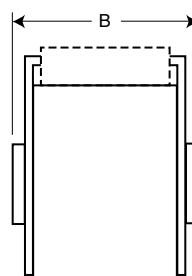
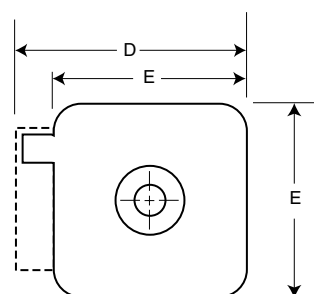



# Square Body - Flush End Contact 690V (IEC) 1000-4000A



Electrical Characteristics						Ordering Information						Curves	
Size	Rated Current RMS-Norm. Cool.	Rated Current RMS-Liquid Cool.	I <sup>2</sup> t (A <sup>2</sup> S)		Watts Loss Norm. Cool.	Watts Loss Liquid Cool.	-B/- Visual Indicator	-BKN/- Type K Indicator for Micro	-G/- Visual Indicator	-GKN/- Type K Indicator for Micro	Carton Qty.	Carton Weight (kg)	See Page
			Pre-arc	Clearing at 660V									
4	1000	1350	76000	505000	175	315	170M7058	170M7078	170M7098	170M7118	2	1.80	page 73
	1250	1700	145000	965000	195	355	170M7059	170M7079	170M7099	170M7119			
	1400	1900	205000	1400000	205	375	170M7060	170M7080	170M7100	170M7120			
	1600	2200	305000	2050000	220	405	170M7061	170M7081	170M7101	170M7121			
	2000	2700	600000	3950000	245	445	170M7062	170M7082	170M7102	170M7122			
	2500	3400	1200000	7800000	275	495	170M7063	170M7083	170M7103	170M7123			
	3000	4100	2000000	13500000	305	555	170M7064	170M7084	170M7104	170M7124			
	3500	4700	3250000	22000000	325	585	170M7065	170M7085	170M7105	170M7125			
	†4000	†5400	4700000	†28000000	355	640	170M7066	170M7086	170M7106	170M7126			

- Interrupting rating 200kA (Estimated 300kA) RMS Symmetrical.
- Watts loss provided at rated current.
- Rated voltage (IEC) †500V
- Liquid Cool. = Liquid cooling. Temperature on the terminals not to exceed 60°C.
- Microswitch indicator ordered separately. See accessories on pages 68-69.

1 kg = 2.2 lbs. 1 lb = 0.45 kg





# Square Body - Flush End Contact 690V (IEC) 1000-4000A



## Electrical Characteristics

### Total Clearing I<sup>2</sup>t

The total clearing I<sup>2</sup>t at rated voltage and at power factor of 15% are given in the electrical characteristics. For other voltages, the clearing I<sup>2</sup>t is found by multiplying by correction factor, K, given as a function of applied working voltage, E<sub>g</sub>, (RMS).

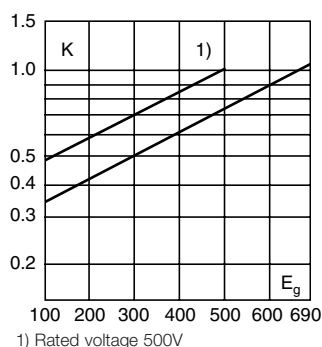

### Arc Voltage

This curve gives the peak arc voltage, U<sub>L</sub>, which may appear across the fuse during its operation as a function of the applied working voltage, E<sub>g</sub>, (RMS) at a power factor of 15%.

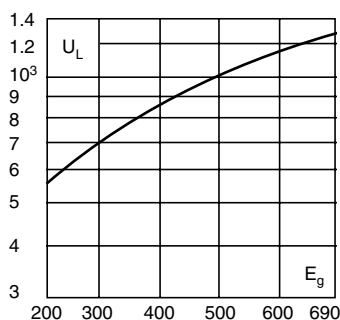

### Power Losses

Watts loss at rated current is given in the electrical characteristics. The curve allows the calculation of the power losses at load currents lower than the rated current. The correction factor, K<sub>p</sub>, is given as a function of the RMS load current, I<sub>b</sub>, in % of the rated current.

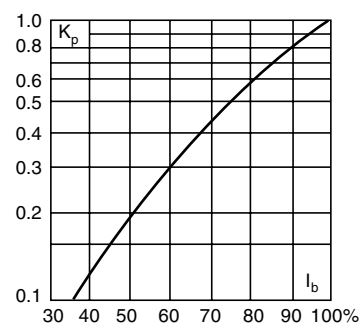

## Dimensions

Flush End Contact: Type 4B/-, 4BKN/-, 4G/-, 4GKN/-

Size	F	G
4B	M10 10 deep	33
4G	1/2" -13 UNC-2B 10 deep	38

Dimension in mm.  
1mm = 0.0394" 1" = 25.4mm

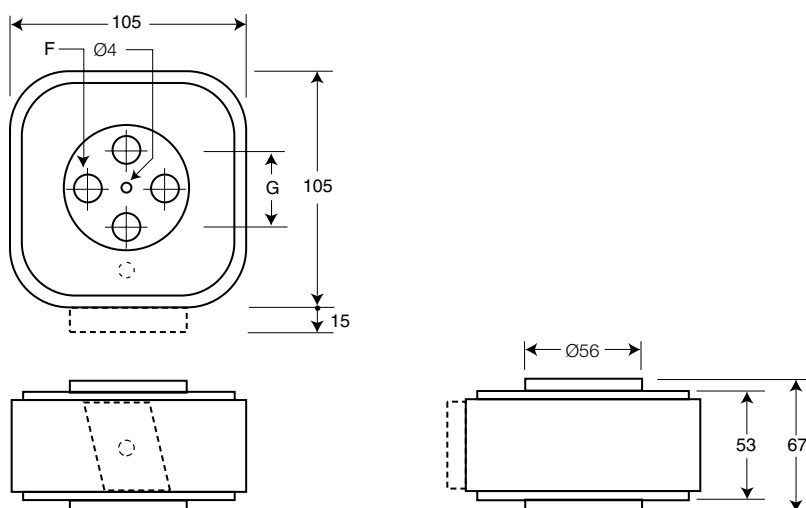



## Square Body - Flush End Contact 1000V (IEC) 50-1400A

Electrical Characteristics						Ordering Information				Curves
Size	Rated Voltage	Rated Current RMS-Amps	I <sup>t</sup> (A <sup>2</sup> s)		Watts Loss	-BKN/-Type K Indicator for Micro	-GKN/-Type K Indicator for Micro	Carton Qty.	Carton Weight (kg)	See Page or (Datasheet)
			Pre-arc	Clearing at Rated Voltage						
1*	1000	50	135	815	20	170M3951	170M3921	6	2.35	Page 74 720077
	1000	63	215	1300	25	170M3952	170M3922			
	1000	80	460	2750	30	170M3953	170M3923			
	1000	100	860	5100	35	170M3954	170M3924			
	1000	125	1450	8600	40	170M3955	170M3925			
	1000	160	2850	17500	45	170M3956	170M3926			
	1000	200	4950	29500	48	170M3957	170M3927			
	1000	250	9550	57000	50	170M3958	170M3928			
	1000	315	21500	130000	60	170M3959	170M3929			
	1000	350	29000	175000	65	170M3960	170M3930			
	1000	400	42000	250000	70	170M3961	170M3931			
1	1000	160	2200	13500	40	170M4951	170M4921	6	3.5	Page 75 720078
	1000	200	4150	24500	45	170M4952	170M4922			
	1000	250	7750	46000	52	170M4953	170M4923			
	1000	315	16500	98500	60	170M4954	170M4924			
	1000	350	21500	130000	65	170M4955	170M4925			
	1000	400	31000	185000	70	170M4956	170M4926			
	1000	450	44500	265000	80	170M4957	170M4927			
	1000	500	63000	375000	85	170M4958	170M4928			
	1000	550	84500	500000	90	170M4959	170M4929			
1000	630	125000	755000	98	170M4960	170M4930				
2	1000	250	6750	40000	65	170M5952	170M5922	3	2.5	Page 75 720079
	1000	315	13500	81500	75	170M5953	170M5923			
	1000	350	16500	99000	80	170M5954	170M5924			
	1000	400	26000	155000	85	170M5955	170M5925			
	1000	450	35500	210000	90	170M5956	170M5926			
	1000	500	49500	295000	95	170M5957	170M5927			
	1000	550	66000	390000	100	170M5958	170M5928			
	1000	630	93500	555000	110	170M5959	170M5929			
	1000	700	130000	770000	115	170M5960	170M5930			
	1000	800	195000	1200000	125	170M5961	170M5931			
3	1000	315	9200	54500	90	170M8600	170M8500	2	2.5	Page 76 720080
	1000	350	13000	77500	95	170M8601	170M8501			
	1000	400	19000	115000	105	170M8602	170M8502			
	1000	450	27000	160000	107	170M8603	170M8503			
	1000	500	37500	225000	110	170M8604	170M8504			
	1000	550	52000	310000	115	170M8605	170M8505			
	1000	630	82500	490000	120	170M8606	170M8506			
	1000	700	115000	700000	125	170M8607	170M8507			
	1000	800	170000	1050000	135	170M8608	170M8508			
	1000	900	250000	1500000	145	170M8609	170M8509			
	1000	1000	340000	2050000	150	170M8610	170M8510			
	1000	1100	460000	2750000	155	170M8611	170M8511			
	1000	1250	575000	3400000	175	170M8612*	170M8512*			
	900	1400	795000	4200000	185	170M8613*	170M8513*			
							1	1.5		

1 kg = 2.2 lbs. 1 lb = 0.45 kg

- Interrupting rating 150kA (Estimated 300kA) RMS Symmetrical.
- Watts loss provided at rated current.
- Microswitch ordered separately. See accessories on page 68-69.
- \*Overall length is 90 mm, for all other fuses the overall length is 75 mm.





# Square Body - Flush End Contact 1000V (IEC) 50-1400A

## Electrical Characteristics

### Total clearing I<sup>2</sup>t

The total clearing I<sup>2</sup>t at rated voltage and at power factor of 15% are given in the electrical characteristics. For other voltages, the clearing I<sup>2</sup>t is found by multiplying by correction factor, K, given as a function of applied working voltage, E<sub>g</sub>, (RMS).

\*Rated voltage 900V

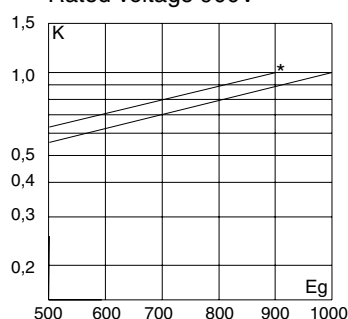

### Arc Voltage

This curve gives the peak arc voltage, U<sub>L</sub>, which may appear across the fuse during its operation as a function of the applied working voltage E<sub>g</sub>, (RMS) at a power factor of 15%.

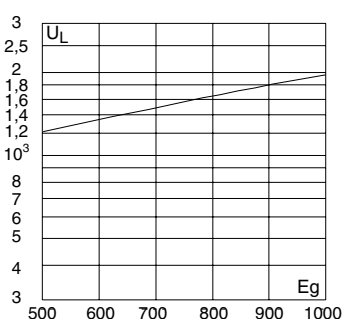

### Power Losses

Watts loss at rated current is given in the electrical characteristics. The curve allows the calculation of the power losses at load currents lower than the rated current. The correction factor, K<sub>p</sub>, is given as a function of the RMS load current, I<sub>b</sub>, in % of the rated current.

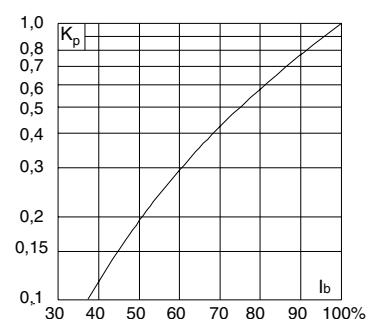

## Dimensions

Flush End Contact Type -BKN/- and -GKN/-

Size	A	B	Max D	E	F	F <sup>§</sup>	Min G	H
1*BKN/75+GKN/75	72.5	74	61	43	M8	5/16" - 18 UNC-2B	5	ø17.5
1BKN/75+GKN/75	73.2	74	69	52	M8	5/16" - 18 UNC-2B	8	ø20
2BKN/75+GKN/75	73.2	74.4	77	59	M10	3/8" - 16 UNC-2B	10	ø24
3BKN/75+GKN/75	73.3	75.4	92	74	M12	1/2" - 13 UNC-2B	10	ø30

Size	A	B	Max D	E	F	F <sup>§</sup>	Min G	H
3BKN/90+GKN/90	80.3	91.4	92	74	M12	1/2" - 13 UNC-2B	10	ø30

§ Valid for fuses type -GKN/-  
Dimensions in mm

1 mm = 0.0394" 1" = 25.4 mm

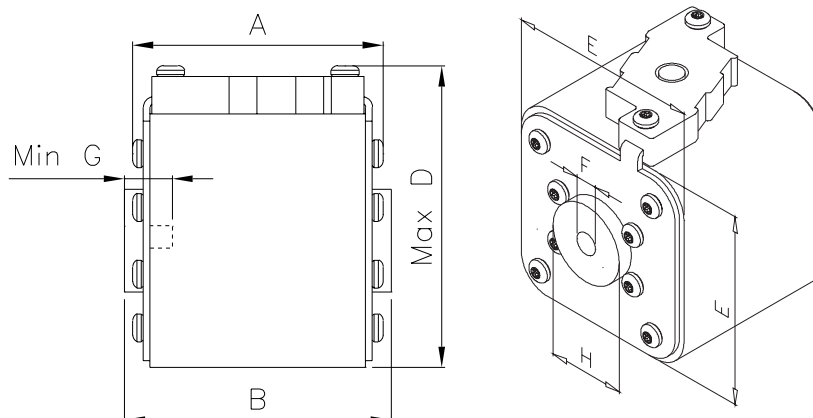

**Square Body – Flush End Contact**
**1250V/1300V (IEC/U.L.) 50-1400A**

Electrical Characteristics						Ordering Information					Curves	
Size	Rated Current RMS-Amps	I <sup>2</sup> t (A <sup>2</sup> S)			Watts Loss	-BKN/75 Type K Indicator for Micro	-BKN/80 Type K Indicator for Micro	-BKN/90 Type K Indicator for Micro	-GKN/75 Type K Indicator for Micro	-GKN/90 Type K Indicator for Micro	See Page or (Datasheet)	
		Pre-arc	Clearing at 1000V	Clearing at 1250V								
1*	50	135	815	1100	15	170M3388	170M3438		170M3488		page 76 (720081)	
	63	215	1300	1750	20	170M3389	170M3439		170M3489			
	80	420	2500	3350	25	170M3390	170M3440		170M3490			
	100	750	4450	5950	30	170M3391	170M3441		170M3491			
	125	1450	9000	11500	35	170M3392	170M3442		170M3492			
	160	2600	16000	21000	40	170M3393	170M3443		170M3493			
	200	5150	31000	41000	45	170M3394	170M3444		170M3494			
	250	9200	54500	73000	55	170M3395	170M3445		170M3495			
	315	18500	115000	150000	60	170M3396	170M3446		170M3496			
	350	27000	165000	220000	65	170M3397	170M3447		170M3497			
	400	53000	265000	335000	70		170M3448					
1	160	1900	11500	15500	45	170M4388	170M4438		170M4488		page 77 (720082)	
	200	3800	22500	30000	50	170M4389	170M4439		170M4489			
	250	7750	46000	61500	60	170M4390	170M4440		170M4490			
	315	15000	90000	120000	65	170M4391	170M4441		170M4491			
	350	20000	125000	165000	70	170M4392	170M4442		170M4492			
	400	29500	175000	235000	75	170M4393	170M4443		170M4493			
	450	42000	250000	335000	80	170M4394	170M4444		170M4494			
	500	69500	340000	435000	85	†170M4395	170M4445		†170M4495			
	550	95000	465000	590000	95	‡170M4396	170M4446		‡170M4496			
	630	130000	660000		100	‡170M4397	†170M4447		‡170M4497			
	2	250	6500	38500	51500	65	170M5388	170M5438		170M5588		
280		9350	55500	74500	70	170M5389	170M5439		170M5589			
315		13000	77500	105000	75	170M5390	170M5440		170M5590			
350		16500	97500	135000	80	170M5391	170M5441		170M5591			
400		23000	140000	180000	85	170M5392	170M5442		170M5592			
450		34000	205000	270000	90	170M5393	170M5443		170M5593			
500		48000	285000	380000	95	170M5394	170M5444	170M5494	170M5594	170M5644		
550		62000	370000	495000	100	170M5395	170M5445	170M5495	170M5595	170M5645		
630		115000	575000	730000	110	†170M5396	170M5446	170M5496	†170M5596	170M5646		
700		160000	795000	1050000	115	‡170M5397	†170M5447	170M5497	‡170M5597	170M5647		
800		245000	1200000	1550000	120	‡170M5398	‡170M5448	170M5498	‡170M5598	170M5648		
†900		360000	1750000		125			170M5499		170M5649		
†1000		480000	2350000		135			170M5500		170M5650		
3	315	9500	58000	77500	85	170M6338	170M6538		170M6588		page 78 (720084)	
	350	13500	81500	110000	90	170M6339	170M6539		170M6589			
	400	19500	120000	160000	95	170M6340	170M6540		170M6590			
	450	31000	185000	245000	100	170M6341	170M6541		170M6591			
	500	39000	235000	310000	105	170M6342	170M6542		170M6592			
	550	55000	325000	435000	110	170M6343	170M6543		170M6593			
	630	83500	495000	665000	115	170M6344	170M6544	170M6494	170M6594	170M6644		
	700	115000	705000	940000	120	170M6345	170M6545	170M6495	170M6595	170M6645		
	800	205000	995000	1300000	125	†170M6346	170M6546	¥170M6496	†170M6596	¥170M6646		
	900	305000	1500000	1900000	130	‡170M6347	†170M6547	¥170M6497	‡170M6597	¥170M6647		
	1000	450000	2150000	2750000	135	‡170M6348	†170M6548	¥170M6498	‡170M6598	¥170M6648		
	1100	575000	2800000	3600000	140	‡170M6349	‡170M6549	¥170M6499	‡170M6599	¥170M6649		
	†1250	810000	3950000		145			170M6500		170M6650		
†1400	1250000	6000000		150			170M6501		170M6651			

■ Interrupting rating 100kA RMS Symmetrical.

1 kg = 2.2 lbs. 1 lb = 0.45 kg

■ Watts loss provided at rated current.

■ Rated voltage (IEC) †1100V ‡1000V ¥1250V (Consult Bussmann for U.L. Recognition/ CSA Component Acceptance status.)

■ Individual Fuse Weight: Size 1\* = 0.380 kg

Size 1 = 0.580 kg

Size 2 = 0.900 kg

Size 3 = 1.250 kg

■ Microswitch indicator ordered separately. See accessories on pages 68-69.





**Square Body - Flush End Contact**

**1250V/1300V (IEC/U.L.) 50-1400A**



**Electrical Characteristics**

**Total Clearing I<sup>2</sup>t**

The total clearing I<sup>2</sup>t at rated voltage and at power factor of 15% are given in the electrical characteristics. For other voltages, the clearing I<sup>2</sup>t is found by multiplying by correction factor, K, given as a function of applied working voltage, E<sub>g</sub>, (RMS).

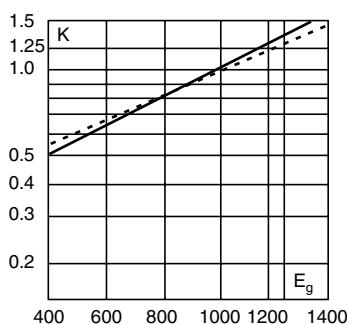

**Arc Voltage**

This curve gives the peak arc voltage, U<sub>L</sub>, which may appear across the fuse during its operation as a function of the applied working voltage, E<sub>g</sub>, (RMS) at a power factor of 15%.

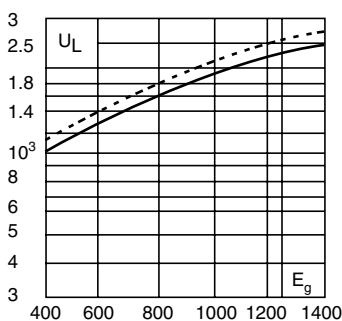

**Power Losses**

Watts loss at rated current is given in the electrical characteristics. The curve allows the calculation of the power losses at load currents lower than the rated current. The correction factor, K<sub>p</sub>, is given as a function of the RMS load current, I<sub>b</sub>, in % of the rated current.

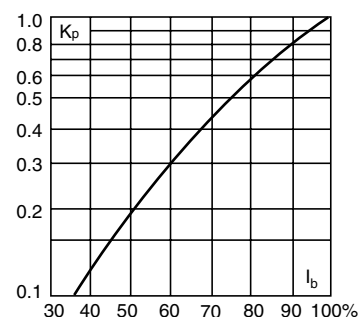

Dashed lines apply to the following amperages:

Size	1*	1	2	3
Amp	400	500-630	630-1000	800-1400

**Dimensions**

Flush End Contact: Type -BKN/-, -GKN/-

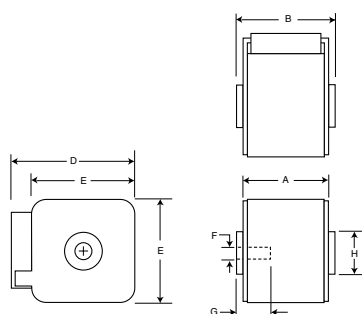

Size	Type	A	B	D	E	F	F <sup>§</sup>	G	H
1*	BKN + GKN/75	74	75	59	45	M8	5/16" - 18 UNC-2B	5	Ø17
1*	BKN/80	80	81	59	45	M8		5	Ø17
1	BKN + GKN/75	74	75	69	53	M8	5/16" - 18 UNC-2B	8	Ø20
1	BKN/80	80	81	69	53	M8		8	Ø20
2	BKN + GKN/75	74	75	77	61	M10	3/8" - 16 UNC-2B	10	Ø24
2	BKN/80	80	81	77	61	M10		10	Ø24
2	BKN + GKN/90	80	91	77	61	M10	3/8" - 16 UNC-2B	10	Ø24
3	BKN + GKN/75	74	76	92	76	M12	1/2" - 13 UNC-2B	10	Ø30
3	BKN/80	81	83	92	76	M12		10	Ø30
3	BKN + GKN/90	81	91	92	76	M12	1/2" - 13 UNC-2B	10	Ø30

<sup>§</sup>Valid for fuses type -GKN/-  
Dimension in mm.  
1mm = 0.0394" 1" = 25.4mm





# Square Body – French Style 690V/700V (IEC/U.L.) 40-1500A



Electrical Characteristics					Ordering Information				Curves
Size	Rated Current RMS-Amps	I <sup>2</sup> t (A <sup>2</sup> S)		Watts Loss	-E/ Type T Indicator For Micro	-EKN/ Type K Indicator for Micro	Carton Qty.	Carton Weight (kg)	See Page or (Datasheet)
		Pre-arc	Clearing at 660V						
1*	40	40	270	9	170M3308	170M3358	1	0.300	page 71 (720085)
	50	77	515	11	170M3309	170M3359			
	63	115	770	14	170M3310	170M3360			
	80	185	1250	18	170M3311	170M3361			
	100	360	2450	21	170M3312	170M3362			
	125	550	3700	26	170M3313	170M3363			
	160	1100	7500	30	170M3314	170M3364			
	200	2200	15000	35	170M3315	170M3365			
	250	4200	28500	40	170M3316	170M3366			
	315	7000	46500	50	170M3317	170M3367			
	350	10000	68500	55	170M3318	170M3368			
	400	15000	105000	60	170M3319	170M3369			
	450	21000	140000	65	170M3320	170M3370			
500	27000	180000	70	170M3321	170M3371				
1	200	1650	11500	45	170M4308	170M4358	1	0.470	page 71 (720086)
	250	3100	21000	55	170M4309	170M4359			
	315	6200	42000	58	170M4310	170M4360			
	350	8500	59000	60	170M4311	170M4361			
	400	13500	91500	65	170M4312	170M4362			
	450	17000	120000	70	170M4313	170M4363			
	500	25000	170000	72	170M4314	170M4364			
	550	34000	230000	75	170M4315	170M4365			
	630	52000	350000	80	170M4316	170M4366			
700	69500	465000	85	170M4317	170M4367				
800	105000	725000	95	170M4318	170M4368				
2	400	11000	74000	65	170M5308	170M5358	1	0.620	page 72 (720087)
	450	15500	105000	70	170M5309	170M5359			
	500	21500	145000	75	170M5310	170M5360			
	550	28000	190000	80	170M5311	170M5361			
	630	41000	275000	90	170M5312	170M5362			
	700	60500	405000	95	170M5313	170M5363			
	800	86000	575000	105	170M5314	170M5364			
	900	125000	840000	110	170M5315	170M5365			
1000	180000	1250000	115	170M5316	170M5366				
3	500	14000	95000	95	170M6308	170M6358	1	0.930	page 72 (720088)
	550	19500	135000	100	170M6309	170M6359			
	630	31000	210000	105	170M6310	170M6360			
	700	44500	300000	110	170M6311	170M6361			
	800	69500	465000	115	170M6312	170M6362			
	900	100000	670000	120	170M6313	170M6363			
	1000	140000	945000	125	170M6314	170M6364			
	1100	190000	1300000	130	170M6315	170M6365			
	1250	290000	1950000	140	170M6316	170M6366			
	1400	370000	2450000	155	170M6317	170M6367			
	1500	460000	3100000	160	170M6318	170M6368			

- Interrupting rating 200kA (Estimated 300kA) RMS Symmetrical.
- Watts loss provided at rated current.
- Microswitch indicator ordered separately. See accessories on pages 68-69.

1 kg = 2.2 lbs. 1 lb = 0.45 kg







# Square Body - French Style 690V/700V (IEC/U.L.) 40-1500A



## Electrical Characteristics

### Total Clearing I<sup>2</sup>t

The total clearing I<sup>2</sup>t at rated voltage and at power factor of 15% are given in the electrical characteristics. For other voltages, the clearing I<sup>2</sup>t is found by multiplying by correction factor, K, given as a function of applied working voltage, E<sub>g</sub>, (RMS).

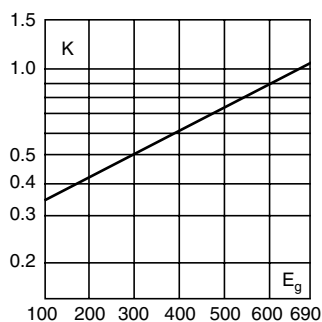

### Arc Voltage

This curve gives the peak arc voltage, U<sub>L</sub>, which may appear across the fuse during its operation as a function of the applied working voltage, E<sub>g</sub>, (RMS) at a power factor of 15%.

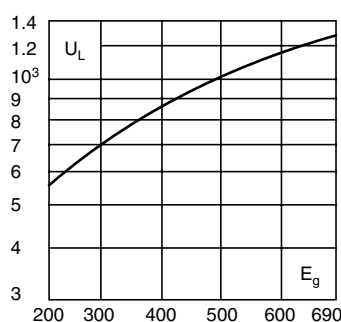

### Power Losses

Watts loss at rated current is given in the electrical characteristics. The curve allows the calculation of the power losses at load currents lower than the rated current. The correction factor, K<sub>p</sub>, is given as a function of the RMS load current, I<sub>b</sub>, in % of the rated current.

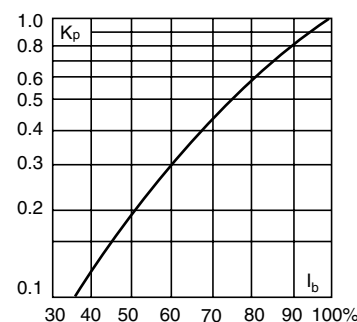

## Dimensions

French Style: Type -E/-, -EKN/-

Size	A	B	C	D	E	H	I	J
1*	50	102	76	59	45	18	9	13
1	50	111	86	69	53	25	11	11
2	50	126	91	77	61	30	13	12
3	51	126	91	92	76	36	13	13

Dimension in mm.  
1mm = 0.0394" 1" = 25.4mm

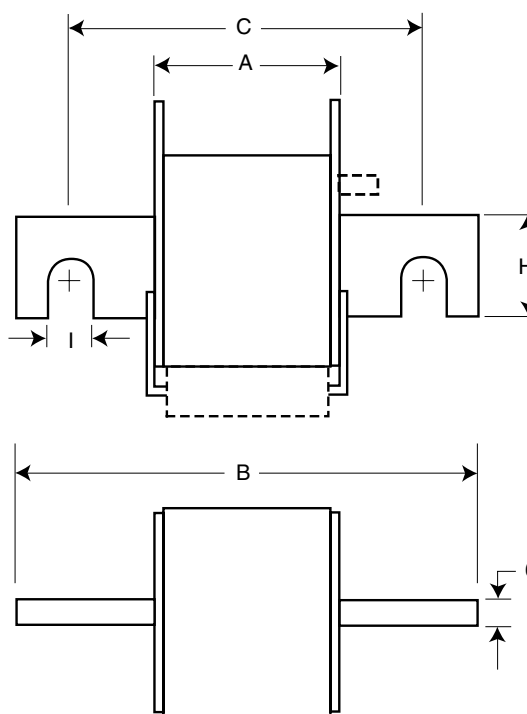



# Square Body - US Style 690V/700V (IEC) 40-2000A



Electrical Characteristics					Ordering Information				Curves		
Size	Rated Current RMS-Amps	I <sup>2</sup> t (A <sup>2</sup> S)		Watts Loss	-FU/ Without Indicator	-FKE/ Type K Indicator for Micro	-FU/115 Without Indicator	-FKE/115 Type K Indicator for Micro	Carton Qty.	Carton Weight (kg)	See Page or (Datasheet)
		Pre-arc	Clearing at 660V								
1*	40	40	270	9	170M3608	170M3658	170M3708	170M3758	1	0.340	page 71 (720089)
	50	77	515	11	170M3609	170M3659	170M3709	170M3759			
	63	115	770	14	170M3610	170M3660	170M3710	170M3760			
	80	185	1250	18	170M3611	170M3661	170M3711	170M3761			
	100	360	2450	21	170M3612	170M3662	170M3712	170M3762			
	125	550	3700	26	170M3613	170M3663	170M3713	170M3763			
	160	1100	7500	30	170M3614	170M3664	170M3714	170M3764			
	200	2200	15000	35	170M3615	170M3665	170M3715	170M3765			
	250	4200	28500	40	170M3616	170M3666	170M3716	170M3766			
	315	7000	46500	50	170M3617	170M3667	170M3717	170M3767			
	350	10000	68500	55	170M3618	170M3668	170M3718	170M3768			
	400	15000	105000	60	170M3619	170M3669	170M3719	170M3769			
	450	21000	140000	65	170M3620	170M3670	170M3720	170M3770			
	500	27000	180000	70	170M3621	170M3671	170M3721	170M3771			
	550	34000	230000	75	170M3622	170M3672	170M3722	170M3772			
630	48500	325000	80	170M3623	170M3673	170M3723	170M3773				
1	200	1650	11500	45	170M4608	170M4658	170M4708	170M4758	1	0.500	page 71 (720090)
	250	3100	21000	55	170M4609	170M4659	170M4709	170M4759			
	315	6200	42000	58	170M4610	170M4660	170M4710	170M4760			
	350	8500	59000	60	170M4611	170M4661	170M4711	170M4761			
	400	13500	91500	65	170M4612	170M4662	170M4712	170M4762			
	450	17000	120000	70	170M4613	170M4663	170M4713	170M4763			
	500	25000	170000	72	170M4614	170M4664	170M4714	170M4764			
	550	34000	230000	75	170M4615	170M4665	170M4715	170M4765			
	630	52000	350000	80	170M4616	170M4666	170M4716	170M4766			
	700	69500	465000	85	170M4617	170M4667	170M4717	170M4767			
	800	105000	725000	95	170M4618	170M4668	170M4718	170M4768			
‡900	155000	‡850000	100	170M4619	170M4669	170M4719	170M4769				
2	400	11000	74000	65	170M5608	170M5658	170M5708	170M5758	1	0.630	page 72 (720091)
	450	15500	105000	70	170M5609	170M5659	170M5709	170M5759			
	500	21500	145000	75	170M5610	170M5660	170M5710	170M5760			
	550	28000	190000	80	170M5611	170M5661	170M5711	170M5761			
	630	41000	275000	90	170M5612	170M5662	170M5712	170M5762			
	700	60500	405000	95	170M5613	170M5663	170M5713	170M5763			
	800	86000	575000	105	170M5614	170M5664	170M5714	170M5764			
	900	125000	840000	110	170M5615	170M5665	170M5715	170M5765			
	1000	180000	1250000	115	170M5616	170M5666	170M5716	170M5766			
	1100	245000	1600000	120	170M5617	170M5667	170M5717	170M5767			
	1250	365000	2400000	130	170M5618	170M5668	170M5718	170M5768			
3	500	14000	95000	95	170M6608	170M6658	170M6708	170M6758	1	0.950	page 72 (720092)
	550	19500	135000	100	170M6609	170M6659	170M6709	170M6759			
	630	31000	210000	105	170M6610	170M6660	170M6710	170M6760			
	700	44500	300000	110	170M6611	170M6661	170M6711	170M6761			
	800	69500	465000	115	170M6612	170M6662	170M6712	170M6762			
	900	100000	670000	120	170M6613	170M6663	170M6713	170M6763			
	1000	140000	945000	125	170M6614	170M6664	170M6714	170M6764			
	1100	190000	1300000	130	170M6615	170M6665	170M6715	170M6765			
	1250	290000	1950000	140	170M6616	170M6666	170M6716	170M6766			
	1400	370000	2450000	155	170M6617	170M6667	170M6717	170M6767			
	1500	460000	3100000	160	170M6618	170M6668	170M6718	170M6768			
	1600	580000	3900000	160	170M6619	170M6669	170M6719	170M6769			
	†1800	880000	†5250000	165	170M6620	170M6670	170M6720	170M6770			
‡2000	1150000	‡6350000	175	170M6621	170M6671	170M6721	170M6771				

- Interrupting rating 200kA (Estimated 300kA) RMS Symmetrical.
  - Watts loss provided at rated current.
  - Rated voltage (IEC) †600V ‡550V (Consult Bussmann for U.L. Recognition/ CSA Component Acceptance status.)
  - Microswitch indicator ordered separately. See accessories on pages 68-69.
- 1 kg = 2.2 lbs. 1 lb = 0.45 kg





# Square Body - US Style 690V/700V (IEC) 40-2000A



## Electrical Characteristics

### Total Clearing I<sup>2</sup>t

The total clearing I<sup>2</sup>t at rated voltage and at power factor of 15% are given in the electrical characteristics. For other voltages, the clearing I<sup>2</sup>t is found by multiplying by correction factor, K, given as a function of applied working voltage, E<sub>g</sub>, (RMS).

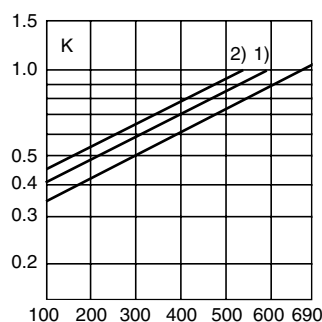

1) Rated voltage 600V  
2) Rated voltage 550V

### Arc Voltage

This curve gives the peak arc voltage, U<sub>L</sub>, which may appear across the fuse during its operation as a function of the applied working voltage, E<sub>g</sub>, (RMS) at a power factor of 15%.

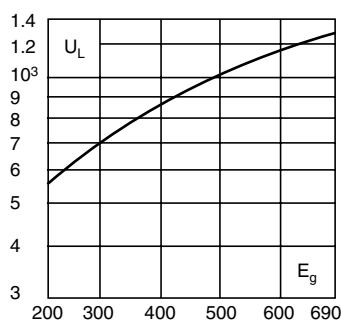

### Power Losses

Watts loss at rated current is given in the electrical characteristics. The curve allows the calculation of the power losses at load currents lower than the rated current. The correction factor, K<sub>p</sub>, is given as a function of the RMS load current, I<sub>b</sub>, in % of the rated current.

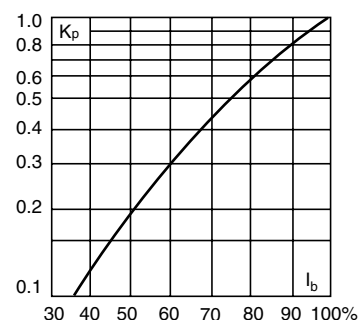

## Dimensions

US Style: Type -FU/-, -FKE/-, FU/115-, -FKE/115

Size	A	B	B <sup>§</sup>	C1	C1 <sup>§</sup>	C2	C2 <sup>§</sup>	D	E	H	I
1*	50	110	148	85	123	72	110	59	45	20	10
1	50	136	157	104	126	78	100	69	53	25	14
2	50	135	159	105	125	78	99	77	61	25	14
3	51	135	155	106	125	77	97	92	76	36	16

<sup>§</sup>Valid for fuses type -FU/115 & -FKE/115  
Dimension in mm.

1mm = 0.0394" 1" = 25.4mm

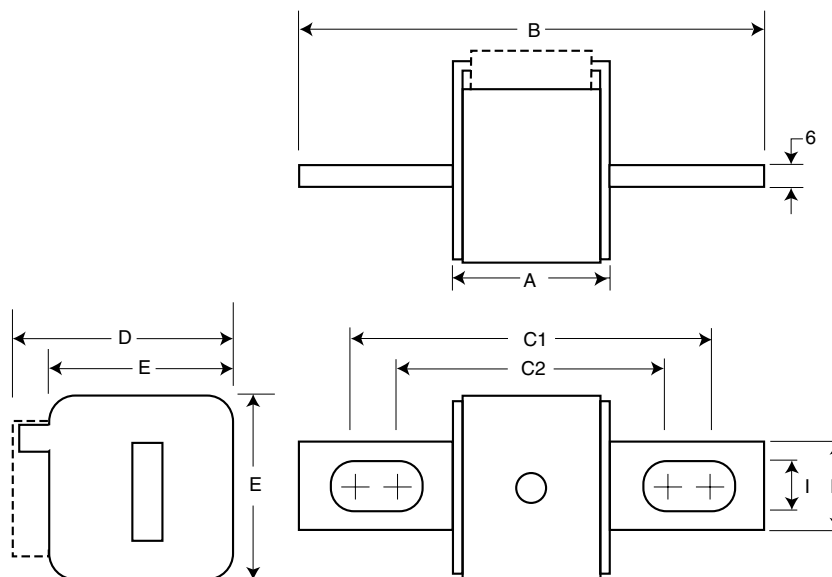



# Square Body - US-Style 1000V (IEC) 50-1400A

Electrical Characteristics						Ordering Information			Curves
Size	Rated Voltage	Rated Current RMS-Amps	I <sup>t</sup> (A <sup>2</sup> s)		Watts Loss	-FKE/115 Type K Indicator for Micro	Carton Qty.	Carton Weight (kg)	See Page or (Datasheet)
			Pre-arc	Clearing at Rated Voltage					
1*	1000	50	135	815	20	170M3531	2	0.85	Page 74 or (720093)
	1000	63	215	1300	25	170M3532			
	1000	80	460	2750	30	170M3533			
	1000	100	860	5100	35	170M3534			
	1000	125	1450	8600	40	170M3535			
	1000	160	2850	17500	45	170M3536			
	1000	200	4950	29500	48	170M3537			
	1000	250	9550	57000	50	170M3538			
	1000	315	21500	130000	60	170M3539			
	1000	350	29000	175000	65	170M3540			
	1000	400	42000	250000	70	170M3541			
1	1000	160	2200	13500	40	170M4531	2	1.4	Page 75 or (720094)
	1000	200	4150	24500	45	170M4532			
	1000	250	7750	46000	52	170M4533			
	1000	315	16500	98500	60	170M4534			
	1000	350	21500	130000	65	170M4535			
	1000	400	31000	185000	70	170M4536			
	1000	450	44500	265000	80	170M4537			
	1000	500	63000	375000	85	170M4538			
	1000	550	84500	500000	90	170M4539			
2	1000	250	6750	40000	65	170M5531	2	1.5	Page 75 or (720095)
	1000	315	13500	81500	75	170M5532			
	1000	350	16500	99000	80	170M5533			
	1000	400	26000	155000	85	170M5534			
	1000	450	35500	210000	90	170M5535			
	1000	500	49500	295000	95	170M5536			
	1000	550	66000	390000	100	170M5537			
	1000	630	93500	555000	110	170M5538			
	1000	700	130000	770000	115	170M5539			
	1000	800	195000	1200000	125	170M5540			
3	1000	315	9200	54500	90	170M8531	1	1.25	Page 76 or (720096)
	1000	350	13000	77500	95	170M8532			
	1000	400	19000	115000	105	170M8533			
	1000	450	27000	160000	107	170M8534			
	1000	500	37500	225000	110	170M8535			
	1000	550	52000	310000	115	170M8536			
	1000	630	82500	490000	120	170M8537			
	1000	700	115000	700000	125	170M8538			
	1000	800	170000	1050000	135	170M8539			
	1000	900	250000	1500000	145	170M8540			
	1000	1000	340000	2050000	150	170M8541			
	1000	1100	460000	2750000	155	170M8542			
	1000	1250	575000	3400000	175	170M8543			
900	1400	795000	4200000	185	170M8544				

1 kg = 2.2 lbs. 1 lb = 0.45 kg

- Interrupting rating 150kA (Estimated 300kA) RMS Symmetrical.
- Watts loss provided at rated current.
- Microswitch ordered separately. See accessories on page 68-69..





# Square Body - US-Style 1000V (IEC) 50-1400A

## Electrical Characteristics

### Total clearing I<sup>2</sup>t

The total clearing I<sup>2</sup>t at rated voltage and at power factor of 15% are given in the electrical characteristics. For other voltages, the clearing I<sup>2</sup>t is found by multiplying by correction factor, K, given as a function of applied working voltage, E<sub>g</sub>, (RMS).

\*Rated voltage 900V

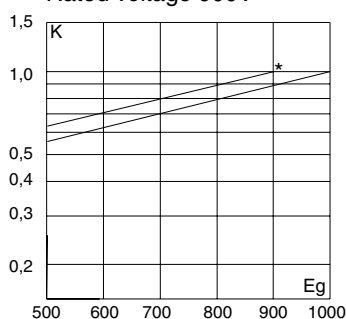

### Arc Voltage

This curve gives the peak arc voltage, U<sub>L</sub>, which may appear across the fuse during its operation as a function of the applied working voltage E<sub>g</sub>, (RMS) at a power factor of 15%.

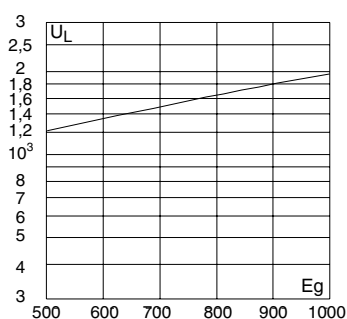

### Power Losses

Watts loss at rated current is given in the electrical characteristics. The curve allows the calculation of the power losses at load currents lower than the rated current. The correction factor, K<sub>p</sub>, is given as a function of the RMS load current, I<sub>b</sub>, in % of the rated current.

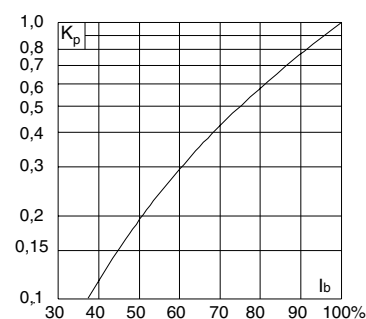

## Dimensions

DIN 43 653: Type -FKE/115

Size	B	C1	C2	D	E	H	I
1*FKE/115	156	130	101	59	45	20	10
1FKE/115	160	127	102	69	53	25	14
2FKE/115	160	127	102	77	61	25	14
3FKE/115	159	128	101	92	76	36	16

Dimensions in mm  
1 mm = 0.0394" 1" = 25.4 mm

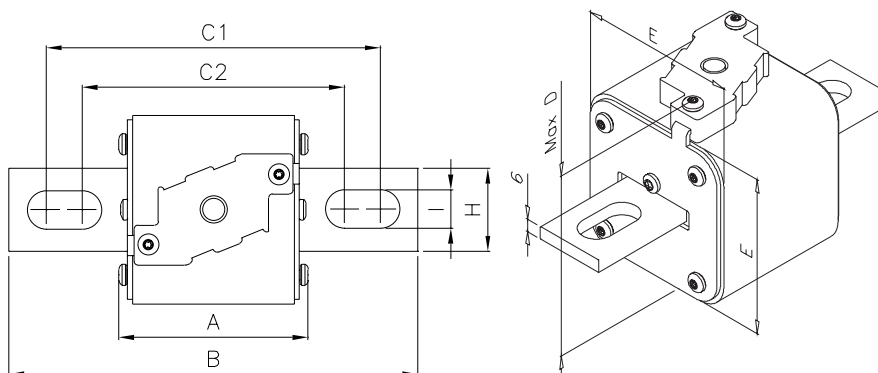



# Square Body - US Style 1250V/1300V (IEC/U.L.) 50-1400A



Electrical Characteristics						Ordering Information				Curves
Size	Rated Current RMS-Amps	I <sup>2</sup> t (A <sup>2</sup> S)			Watts Loss	-FU/115 Without Indicator	-FKE/115 Type K Indicator for Micro	Carton Qty.	Carton Weight (kg)	See Page or (Datasheet)
		Pre-arc	Clearing at 1000V	Clearing at 1250V						
1*	50	135	815	1100	15	170M3688	170M3738	1	0.425	page 76 (720097)
	63	215	1300	1750	20	170M3689	170M3739			
	80	420	2500	3350	25	170M3690	170M3740			
	100	750	4450	5950	30	170M3691	170M3741			
	125	1450	9000	11500	35	170M3692	170M3742			
	160	2600	16000	21000	40	170M3693	170M3743			
	200	5150	31000	41000	45	170M3694	170M3744			
	250	9200	54500	73000	55	170M3695	170M3745			
	315	18500	115000	150000	60	170M3696	170M3746			
	350	27000	165000	220000	65	170M3697	170M3747			
1	160	1900	11500	15500	45	170M4688	170M4738	1	0.675	page 77 (720098)
	200	3800	22500	30000	50	170M4689	170M4739			
	250	7750	46000	61500	60	170M4690	170M4740			
	315	15000	90000	120000	65	170M4691	170M4741			
	350	20000	125000	165000	70	170M4692	170M4742			
	400	29500	175000	235000	75	170M4693	170M4743			
	450	42000	250000	335000	80	170M4694	170M4744			
	†500	69500	340000		85	170M4695	170M4745			
	†550	95000	465000		95	170M4696	170M4746			
	‡630	130000	660000		100	170M4697	170M4747			
2	250	6500	38500	51500	65	170M5688	170M5738	1	0.740	page 77 (720099)
	280	9350	55500	74500	70	170M5689	170M5739			
	315	13000	77500	105000	75	170M5690	170M5740			
	350	16500	97500	135000	80	170M5691	170M5741			
	400	23000	140000	180000	85	170M5692	170M5742			
	450	34000	205000	270000	90	170M5693	170M5743			
	500	48000	285000	380000	95	170M5694	170M5744			
	550	62000	370000	495000	100	170M5695	170M5745			
	630	115000	575000	730000	110	170M5696	170M5746			
	†700	160000	795000		115	170M5697	170M5747			
†800	245000	1200000		120	170M5698	170M5748				
†900	360000	1750000		125	170M5699	170M5749				
‡1000	480000	2350000		135	170M5700	170M5750				
3	315	9500	58000	77500	185	170M6688	170M6738	1	1.250	page 78 (720100)
	350	13500	81500	110000	90	170M6689	170M6739			
	400	19500	120000	160000	95	170M6690	170M6740			
	450	31000	185000	245000	100	170M6691	170M6741			
	500	39000	235000	310000	105	170M6692	170M6742			
	550	55000	325000	435000	110	170M6693	170M6743			
	630	83500	495000	665000	115	170M6694	170M6744			
	700	115000	705000	940000	120	170M6695	170M6745			
	800	205000	995000	1300000	125	170M6696	170M6746			
	900	305000	1500000	1900000	130	170M6697	170M6747			
¥1000	450000	2150000		135	†170M6698	†170M6748				
¥1100	575000	2800000		140	†170M6699	†170M6749				
¥1250	810000	3950000		145	‡170M6700	‡170M6750				
¥1400	1250000	6000000		150	‡170M6701	‡170M6751				

¥ U.L. Recognition at 1000V.

1 kg = 2.2 lbs. 1 lb = 0.45 kg

- Interrupting rating 100kA RMS Symmetrical.
- Watts loss provided at rated current.
- Rated voltage (IEC) †1100 ‡1000V (Consult Bussmann for U.L. Recognition/ CSA Component Acceptance status.)
- Microswitch indicator ordered separately. See accessories on pages 68-69.





# Square Body - US Style 1250V/1300V (IEC/U.L.) 50-1400A



## Electrical Characteristics

### Total Clearing I<sup>2</sup>t

The total clearing I<sup>2</sup>t at rated voltage and at power factor of 15% are given in the electrical characteristics. For other voltages, the clearing I<sup>2</sup>t is found by multiplying by correction factor, K, given as a function of applied working voltage, E<sub>g</sub>, (RMS).

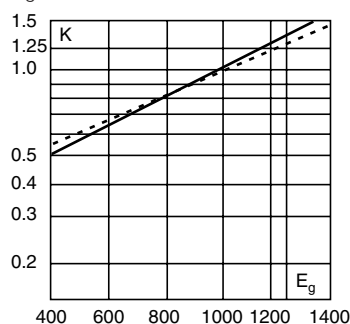

### Arc Voltage

This curve gives the peak arc voltage, U<sub>L</sub>, which may appear across the fuse during its operation as a function of the applied working voltage, E<sub>g</sub>, (RMS) at a power factor of 15%.

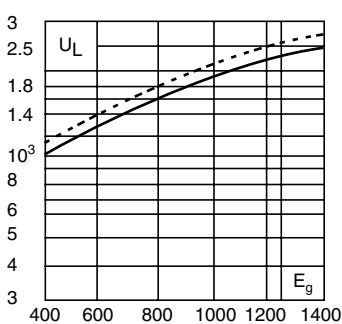

### Power Losses

Watts loss at rated current is given in the electrical characteristics. The curve allows the calculation of the power losses at load currents lower than the rated current. The correction factor, K<sub>p</sub>, is given as a function of the RMS load current, I<sub>b</sub>, in % of the rated current.

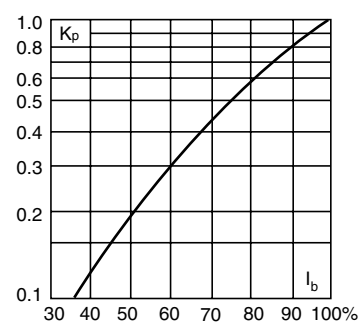

-----  
Dashed lines apply to the following amperages:

Size	1*	1	2	3
Amp	400	500-630	630-1000	800-1400

## Dimensions

US Style: Type -FU/115, -FKE/115

Size	B	C1	C2	D	E	H	I
1*	156	130	101	59	45	20	10
1	160	127	102	69	53	25	14
2	160	127	102	77	61	25	14
3	159	128	101	92	76	36	16

Dimension in mm.  
1mm = 0.0394" 1" = 25.4mm

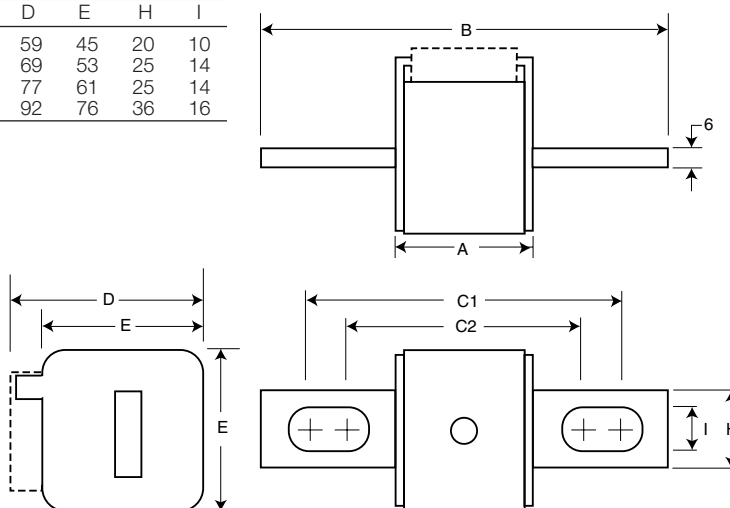



## Square Body – Accessories Indicator System



### Indicators

Typower ZILOX fuses are available with three different indicator systems.

#### Visual Indicator

The indicator situated in one cover plate is clearly visible as soon as the fuse has operated. The minimum voltage for operating the indicator is 20V.

#### Type T Indicator

The indicator is situated on one cover plate with a cover plate tag to accommodate an auxiliary switch. The minimum voltage for operating the indicator is 20V. A special low voltage indicator (1.5V) is available on request.

#### Type K Indicator

This indicator is situated on the fuse body. It is covered by an adaptor for snap-on mounting of an auxiliary switch. The operating voltage of the indicator is 1.5V. As a matter of safety, the factory mounted adaptor must not be removed from the fuse.

### Microswitch

The Typower ZILOX fuses with either type T indicator or type K indicator can be equipped with a microswitch for remote electrical indication of fuse operations. All microswitches have one normally open and one normally closed contact. Ratings are 2A, 250 Vac.



Microswitch	6.3 x 0.8 mm Lugs	2.8 x 0.5 mm Lugs	Indicator Type
170H0235	x		T
170H0236	x		T
170H0237		x	T
170H0238		x	T
170H0069	x		K

Size	DIN 43 653		DIN 43 620		French Style		Flush End		US Style
	Type T	Type K	Type T	Type K	Type T	Type K	Type T	Type K	Type K
000	170H0236 170H0238		170H0236 170H0238						
00	170H0235 170H0237						170H0235 170H0237		
1*	170H0235 170H0237	170H0069	170H0235 170H0237		170H0236 170H0238	170H0069		170H0069	170H0069
1	170H0235 170H0237	170H0069			170H0236 170H0238	170H0069		170H0069	170H0069
2	170H0235 170H0237	170H0069	170H0235 170H0237		170H0236 170H0238	170H0069		170H0069	170H0069
3	170H0235 170H0237	170H0069	170H0236 170H0238		170H0236 170H0238	170H0069		170H0069	170H0069
4								170H0069	
23								170H0069	
24								170H0069	

BIF document: 720034







## Square Body – Accessories

# Fuse Bases (Blocks)



### DIN 43 653 Fuse Bases

For the Typower ZILOX fuses according to DIN 43 653, the following fuse bases are available:

Part Number	Max. Voltage	Rated Current	Center Distance
170H3003	1000V	630A	80mm
170H3004	1000V	1250A	80mm
170H3005	1400V	630A	110mm
170H3006	1400V	1250A	110mm

The fuse bases rated 1250A can also be used for the fuses with higher rated current if the maximum load current is derated according to the table below:

Fuse Rating	Max. Load Current In Fuse Base
1400A	1325A
1500A	1400A
1600A	1500A
1800A	1650A
2000A	1800A

Fixed Center Base Style	Max. Voltage	Max. Fuse Current Rating	Fuse Size
170H1007	1000V	400A	00, 000
170H1013	660V	200A	0000,000

U.L. Recognized to U.L. 512.

### Universal Fuse Bases

For the Typower ZILOX fuses according to DIN 43 653, French style and North American style, the following fuse bases are available:

Modular Base Style	Max. Voltage	Max. Fuse Current Rating	BIF Document
1BS101	600V	100A	1206
1BS102	600V	400A	1207
1BS103	600V	400A	1208
1BS104	600V	600A	1209
BH-0xxx	700V	100A	1200
BH-1xxx	2500V	400A	1201
BH-2xxx	5000V	400A	1202
BH-3xxx	1250V	700A	1203

Modular fuse bases are U.L. Recognized to U.L. 512 and meet the spacing requirements of U.L. 347. Contact Bussmann sales representative for more complete ordering information.

### DIN 43 620 Fuse Bases

For fuse bases used with Typower ZILOX fuses according to DIN 43 620, please contact your local Bussmann sales representative.

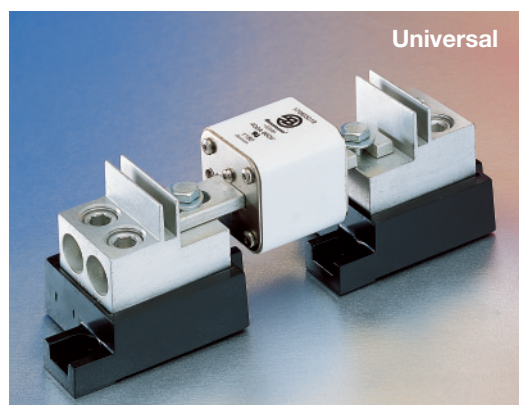
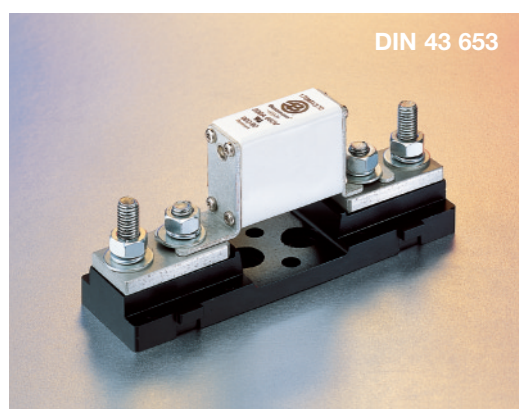
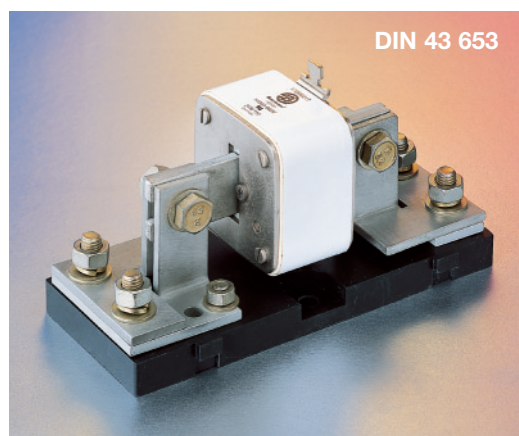



# Square Body Curves

## Size 000: 690V (10-315)A Time-Current Curve

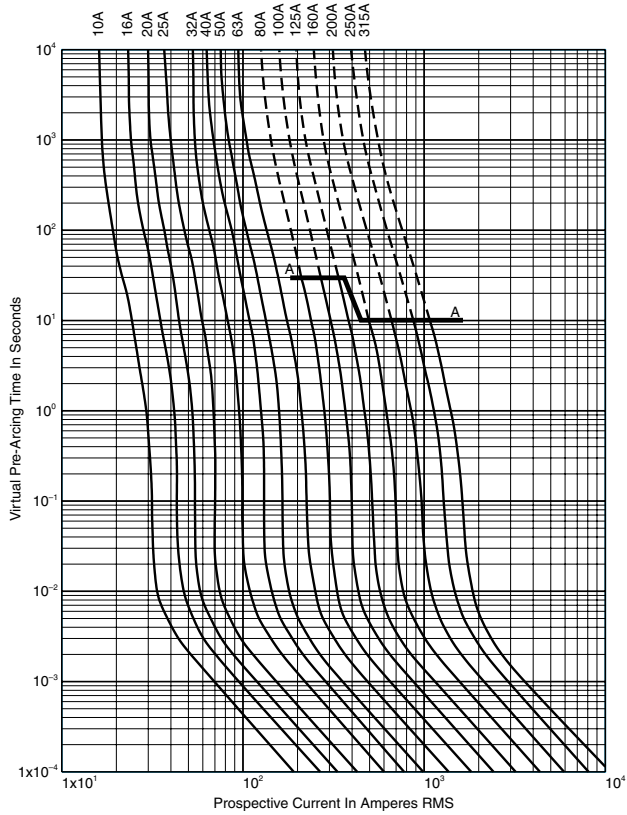

## Peak Let-Through Curve

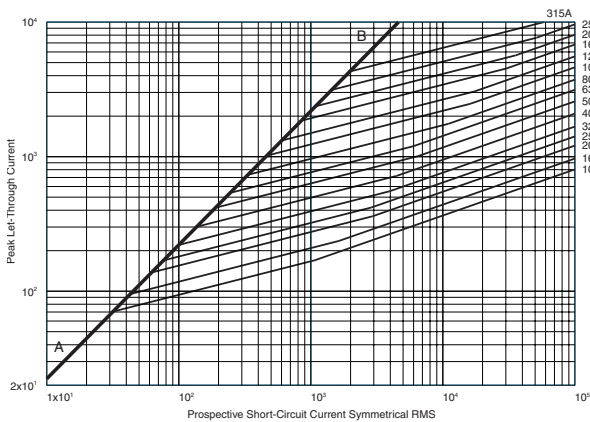

BIF document: 17056310

## Size 00: 690V (25-400)A Time-Current Curve

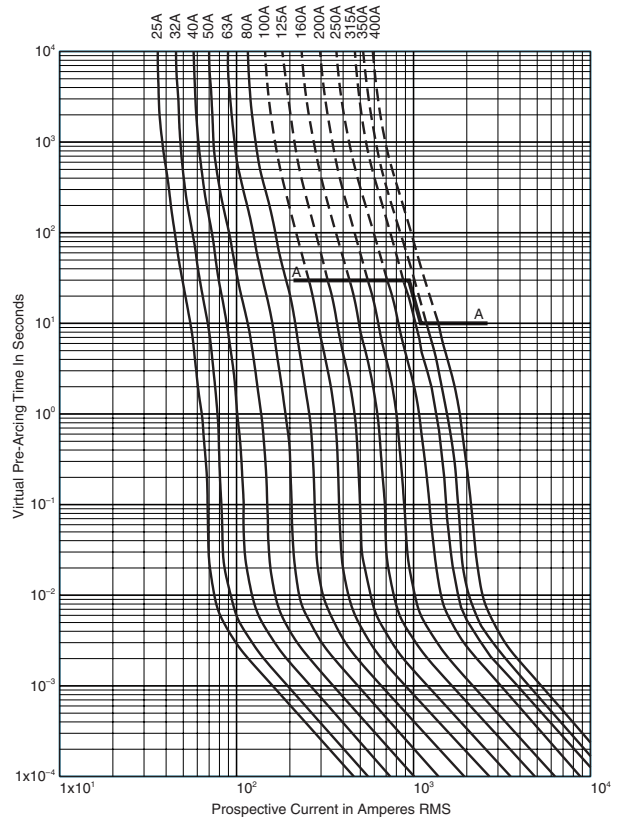

## Peak Let-Through Curve

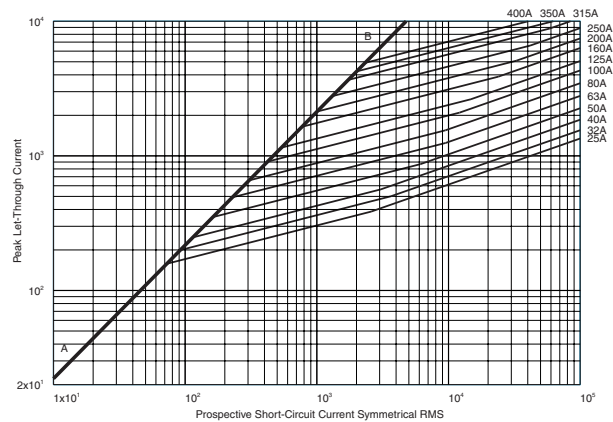

BIF document: 17056312





# Square Body Curves

## Size 1\*: 690V (40-630)A Time-Current Curve

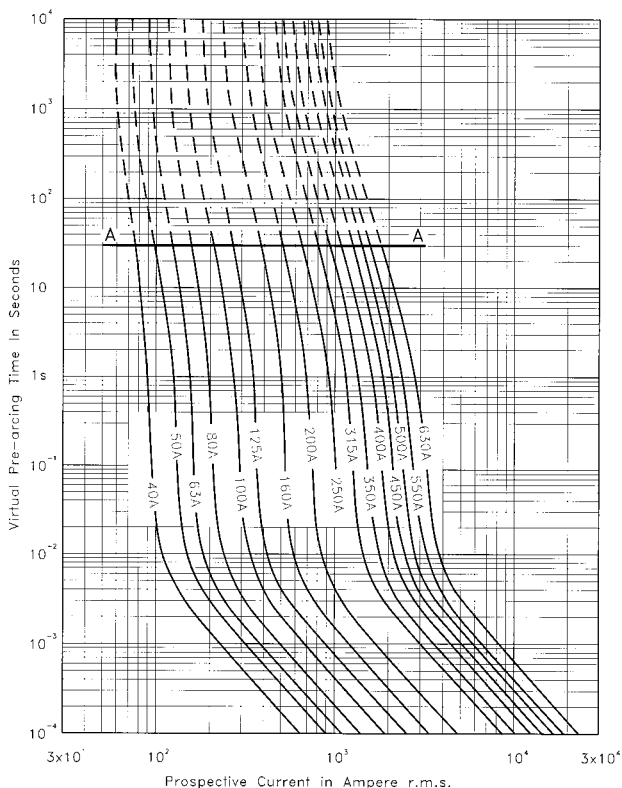

### Peak Let-Through Curve

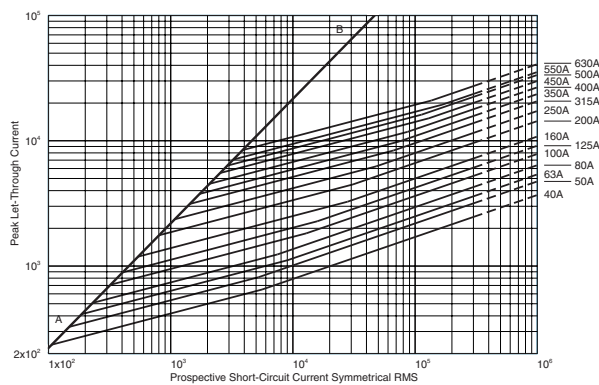

## Size 1: 690V (200-900)A Time-Current Curve

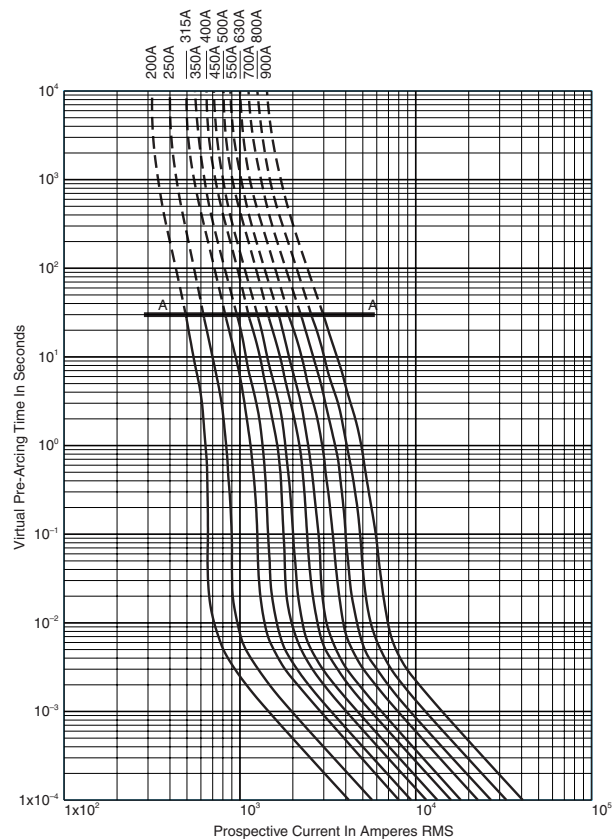

### Peak Let-Through Curve

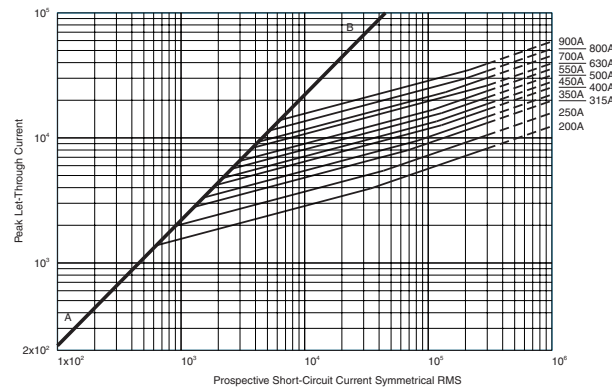

900 amp fuse is derated to 550V (IEC).





# Square Body Curves

## Size 2: 690V (400-1250)A Time-Current Curve

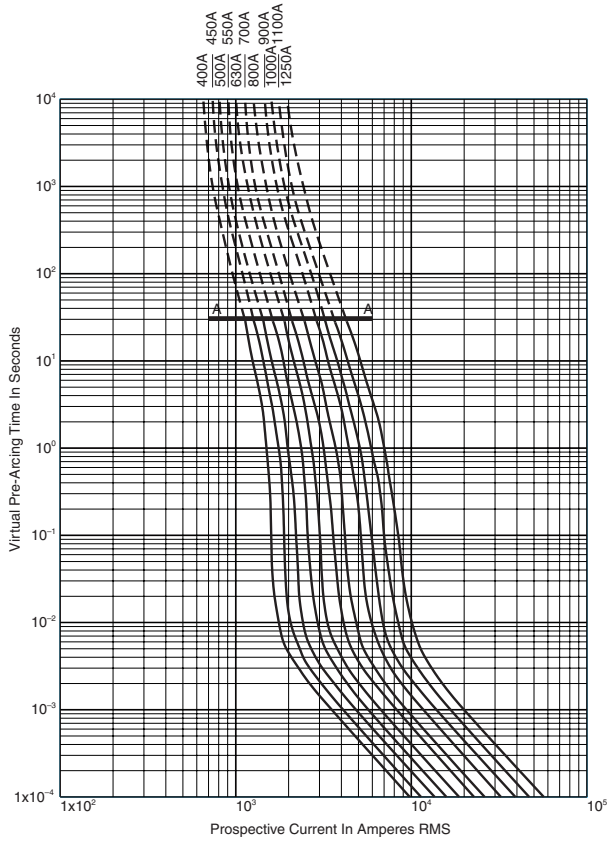

### Peak Let-Through Curve

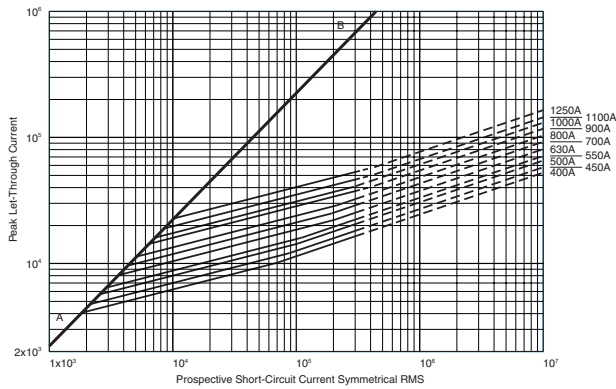

BIF document: 17056318

## Size 3: 690V (500-2000)A Time-Current Curve

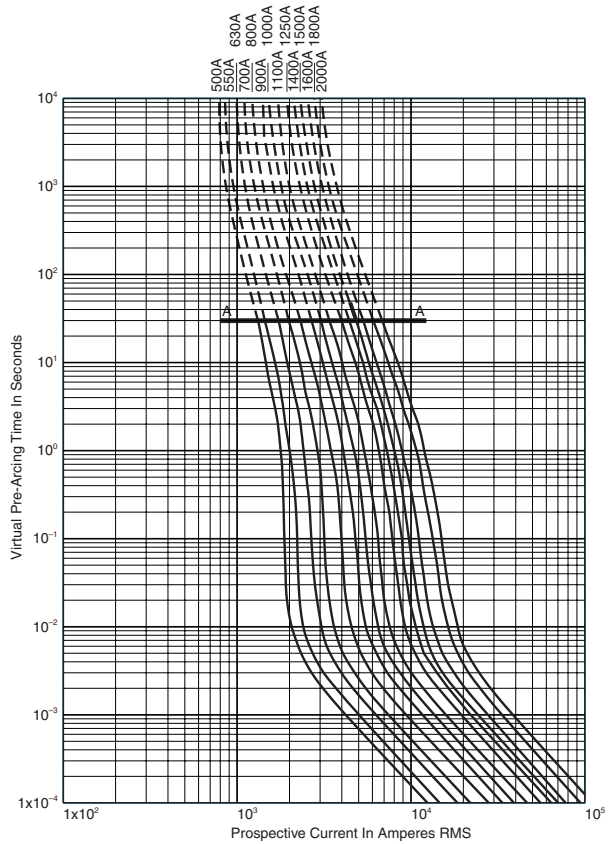

### Peak Let-Through Curve

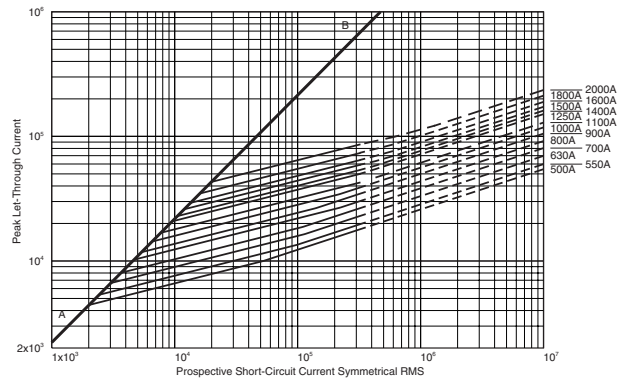

1800 amp fuse is derated to 600V (IEC).  
2000 amp fuse is derated to 550V (IEC).

BIF document: 17056320





# Square Body Curves

## Size 4: 690V (1000-4000)A Time-Current Curve

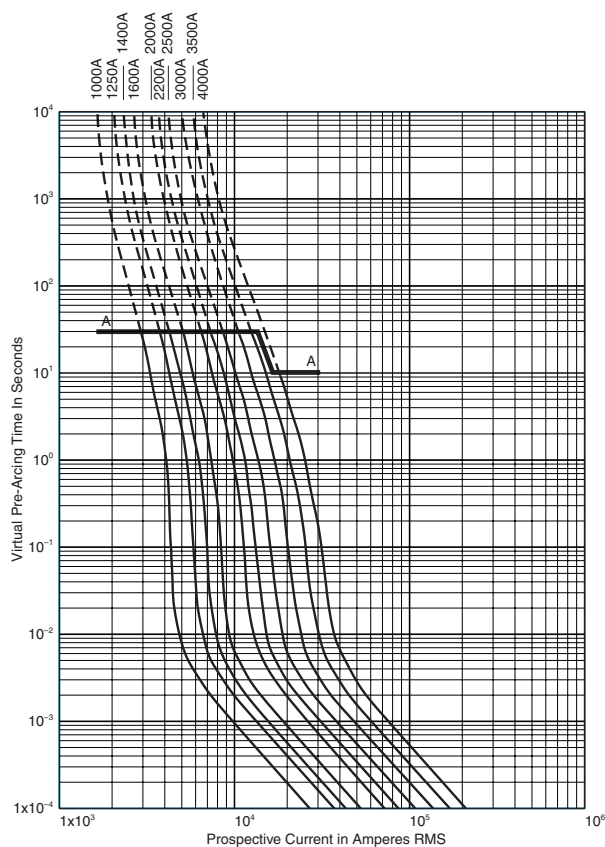

## Peak Let-Through Curve

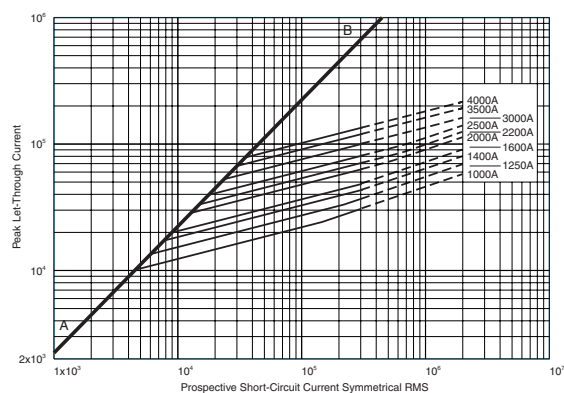

4000 amp fuse is derated to 500V (IEC).

## Size 00: 1000V (20-315)A Time-Current Curve

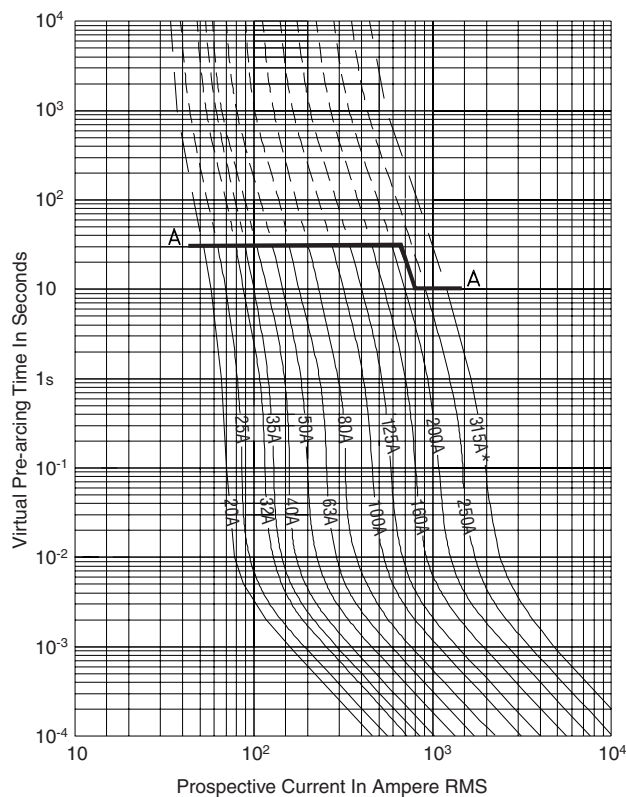

## Peak Let-Through Curve

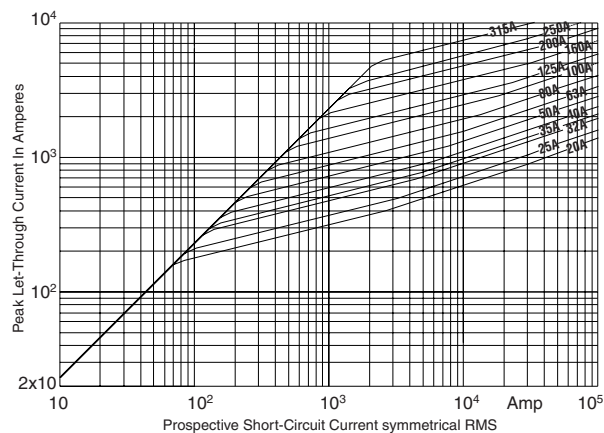

\* 315 amp fuse is derated to 900V

BIF document: 17056328

BIF document: 17058504



For complete specification data, visit our Web site at [www.bussmann.com](http://www.bussmann.com) or call Bussmann Information Fax ~ 636.527.1450





# Square Body Curves

**Size 00: 1000V (20-225)A**  
Time-Current Curve

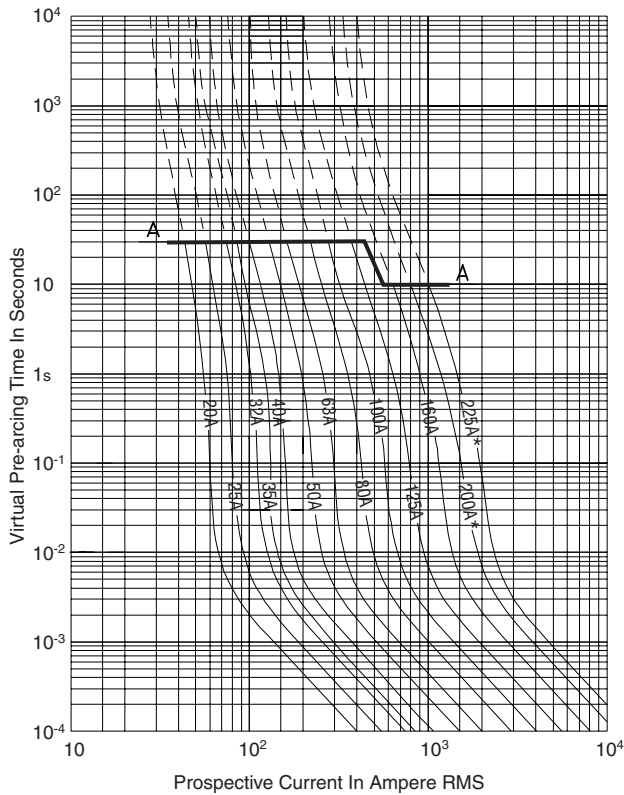

**Size 1\*: 1000V (50-400)A**  
Time-Current Curve

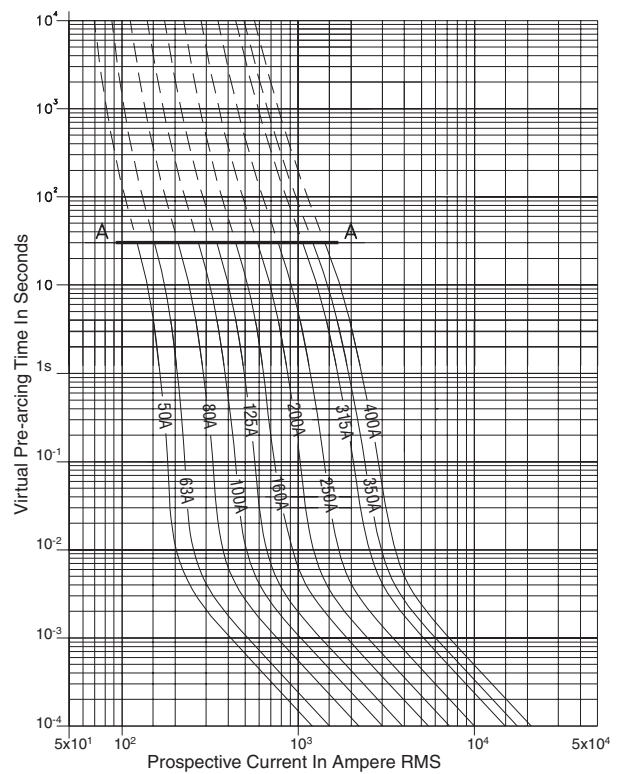

**Peak Let-Through Curve**

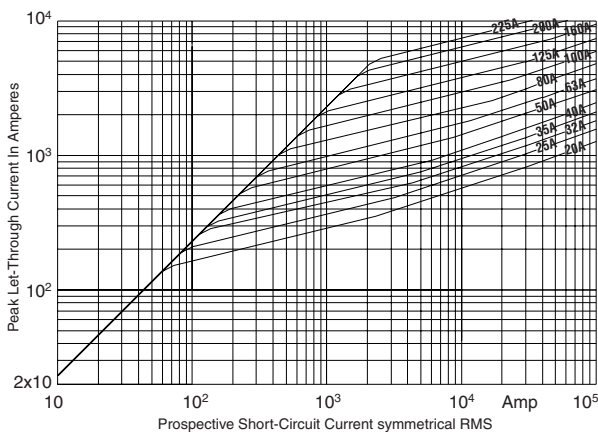

**Peak Let-Through Curve**

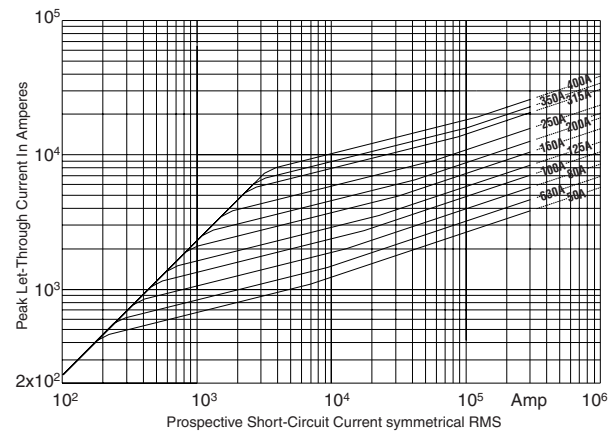

\* 200-225 amp fuses are derated to 900V





# Square Body Curves

**Size 1: 1000V (160-630)A**  
Time-Current Curve

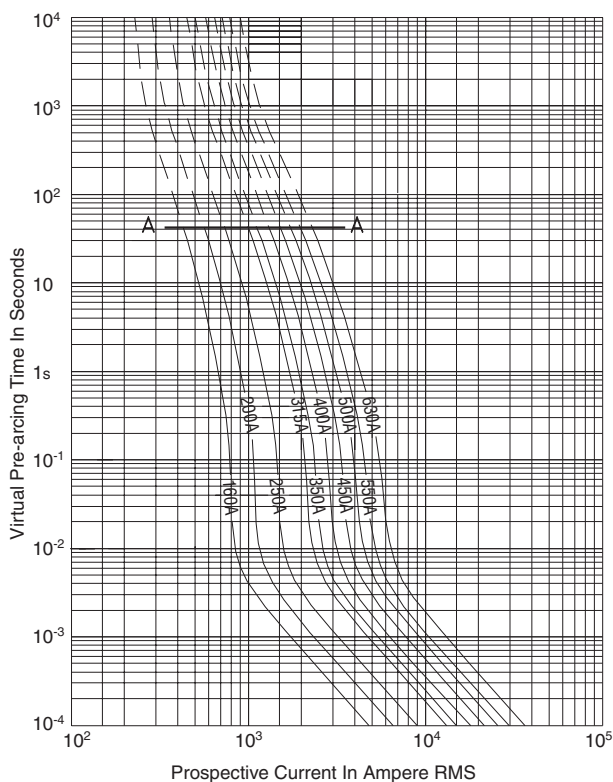

**Size 2: 1000V (250-800)A**  
Time-Current Curve

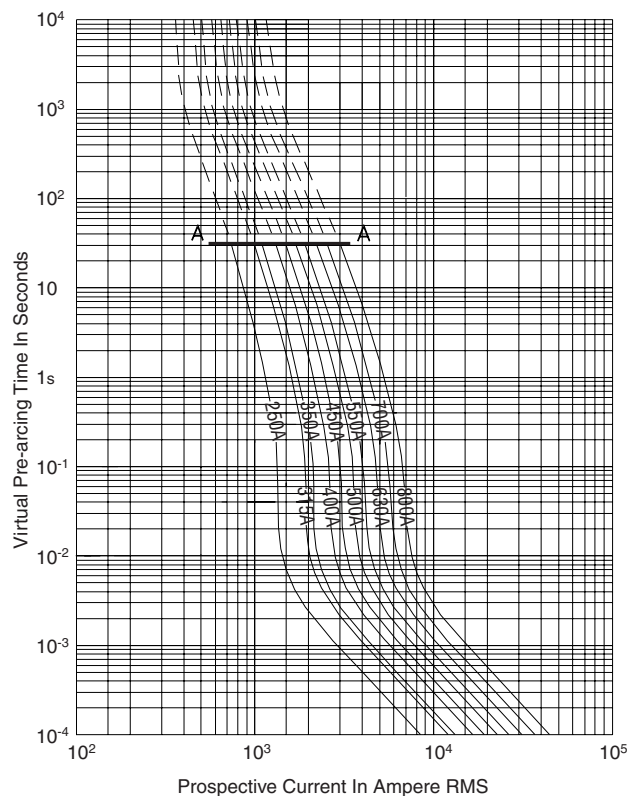

**Peak Let-Through Curve**

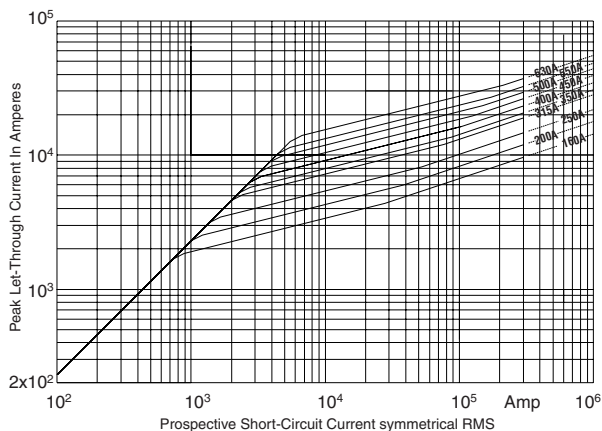

**Peak Let-Through Curve**

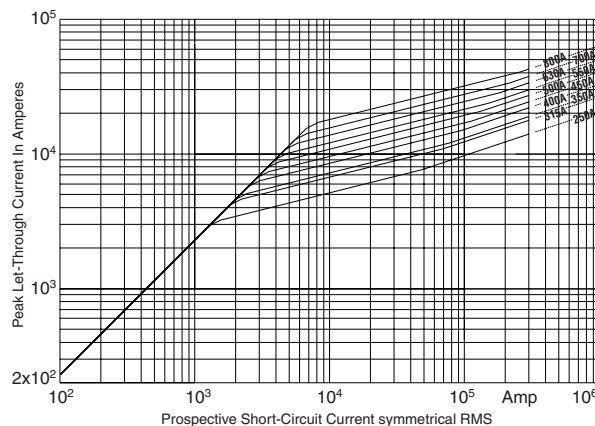

BIF document: 17058566

BIF document: 17058568



For complete specification data, visit our Web site at [www.bussmann.com](http://www.bussmann.com)  
or call Bussmann Information Fax ~ 636.527.1450



## Square Body Curves

### Size 3: 1000V (315-1400)A Time-Current Curve

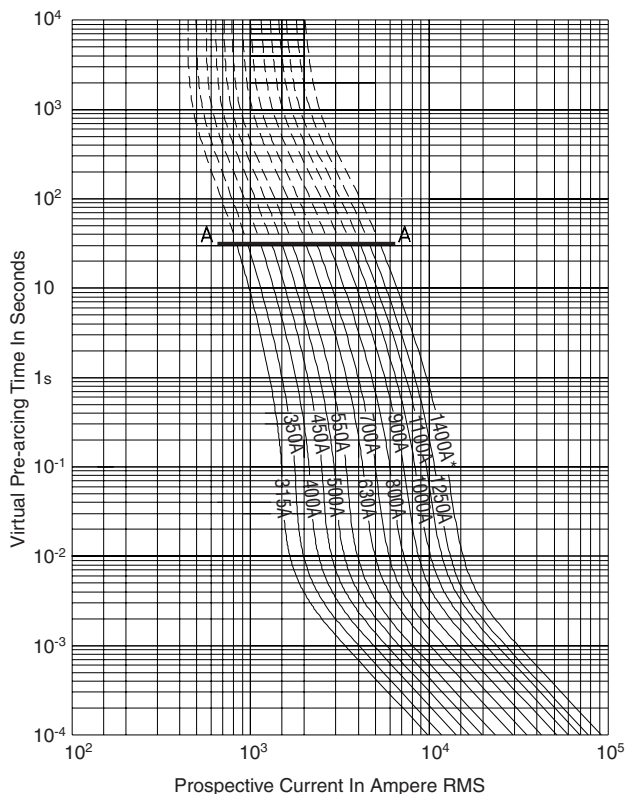

### Peak Let-Through Curve

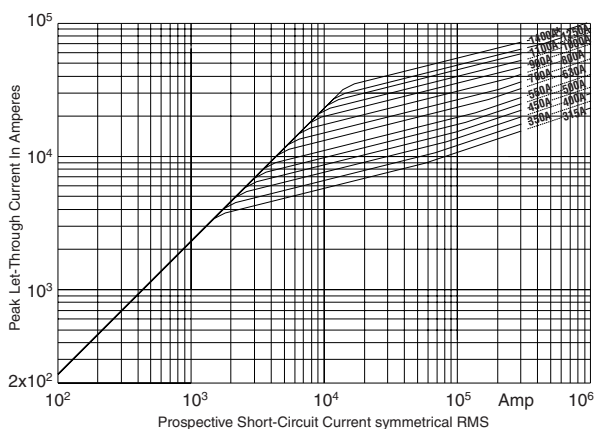

\* 1400 amp fuses are derated to 900V

BIF document: 17058570

### Size 1\*: 1250V (50-400)A Time-Current Curve

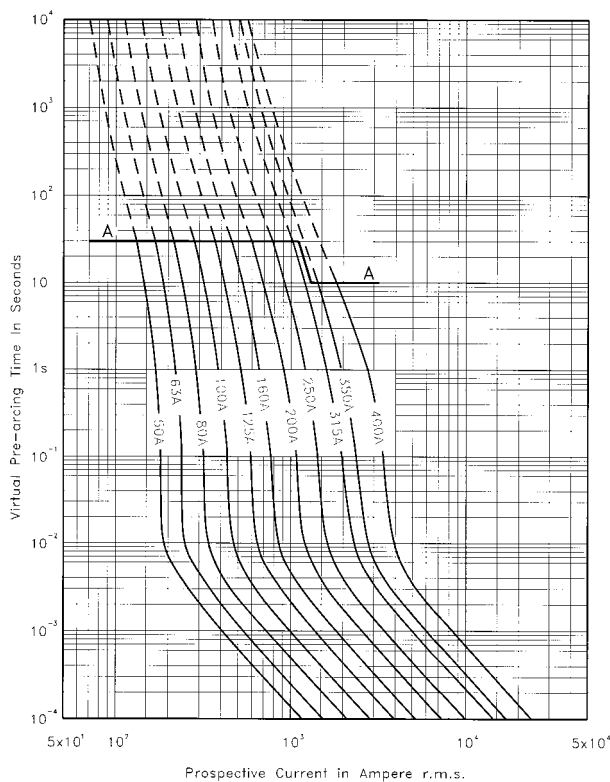

### Peak Let-Through Curve

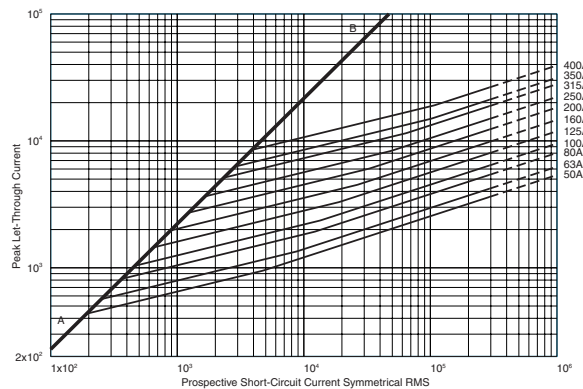

BIF document: 17056630







# Square Body Curves

**Size 1: 1250V (160-630)A**  
Time-Current Curve

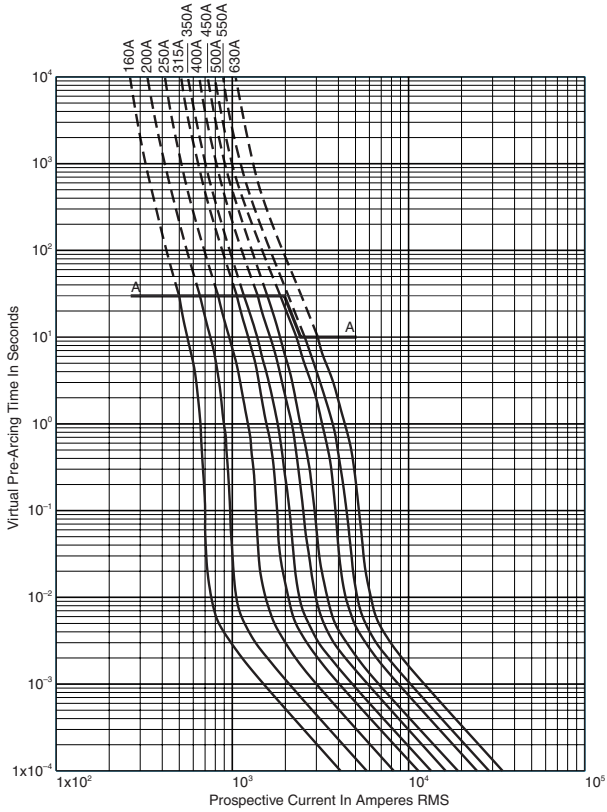

**Size 2: 1250V (250-1000)A**  
Time-Current Curve

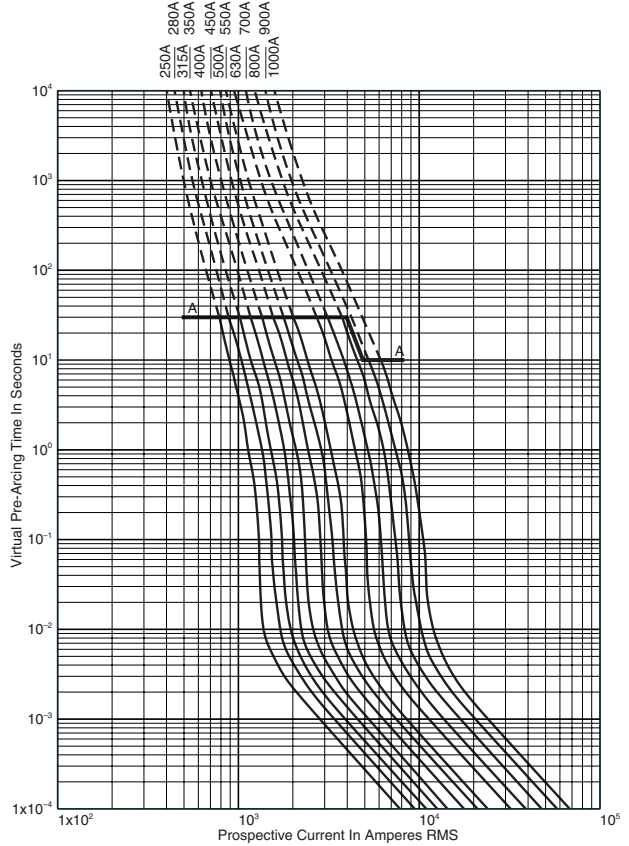

**Peak Let-Through Curve**

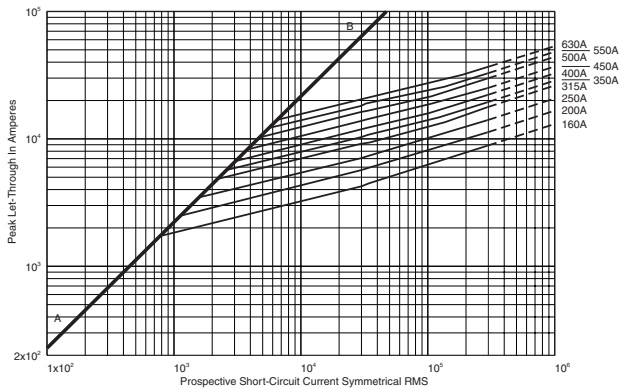

**Peak Let-Through Curve**

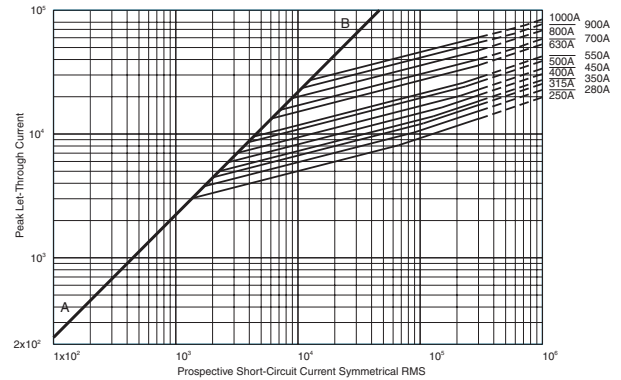

630 amp fuse is derated to 1100V (IEC).

900-1000 amp fuses are derated to 1100V (IEC).

BIF document: 17056632

BIF document: 17056634



For complete specification data, visit our Web site at [www.bussmann.com](http://www.bussmann.com)  
or call Bussmann Information Fax ~ 636.527.1450



**European Square Body  
Curves**



**Size 3: 1250V (315-1400)A  
Time-Current Curve**

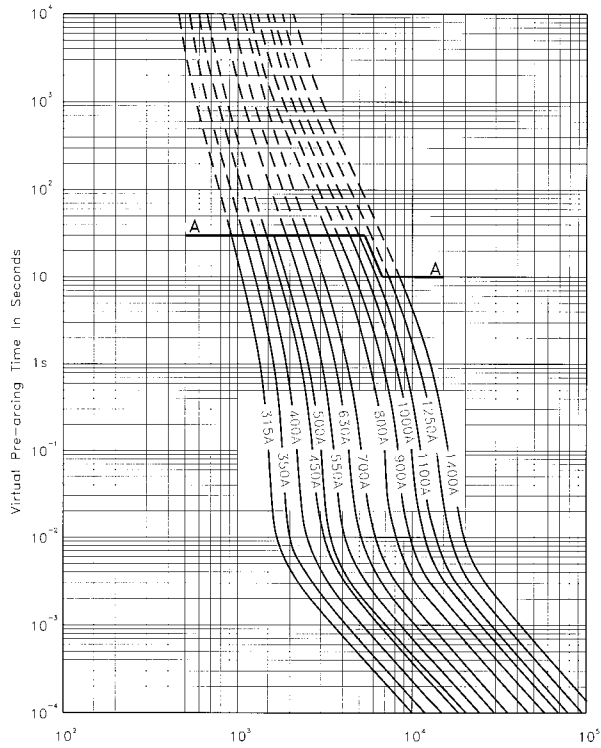

**Peak Let-Through Curve**

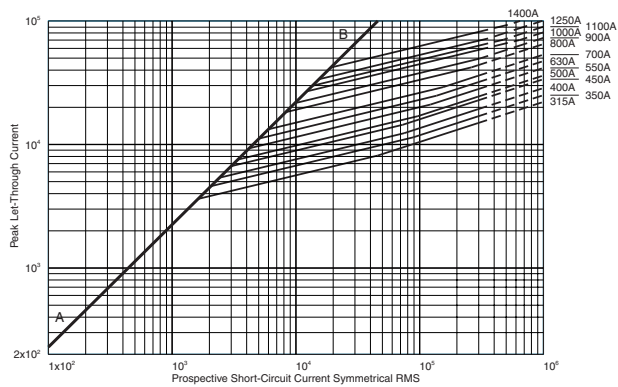





1250-1400 amp fuses are derated to 1100V (IEC).

**BIF document: 17056636**



## Table of Contents

<b>General Applications</b>	<b>2-4</b>		
 <b>North American</b>	<b>5</b>	 <b>British BS 88</b>	<b>79</b>
FWA 130V 1000-4000A	6-7	240V 6-900A	80-81
FWA 150V 70-1000A	8-9	690V 6-700A	82-83
FWX 250V 35-2500A	10-11	Accessories	84
FWH 500V 35-1600A	12-13	Time-Current & Peak Let-Through Curves	85-89
KAC 600V 1-1000A	14		
KBC 600V 35-800A	15	 <b>Ferrule</b>	<b>91</b>
FWP 700V 5-1200A	16-17	FWA 150V 5-60A	92
FWJ 1000V 35-2000A	18-19	FWX 250V 1-30A	93
Accessories	20	FWH 500V 0.25-30A	94-95
Time-Current & Peak Let-Through Curves	21-26	FWC 600V 6-32A	96
		FWP 660V/700V 1-100A	97-98
 <b>Square Body</b>	<b>27</b>	FWK 750V 5-60A	99
Applications	28-29	FWJ 1000V 20-30A	100
DIN 43 653	30-43	FWL/FWS 1250/1500/2000V 2-30A	101
DIN 43 620	44-49	Accessories	102
Flush End Contact	50-59	Time-Current & Peak Let-Through Curves	103-108
French Style	60-61		
US Style	62-67		
Accessories	68-69		
Time-Current & Peak Let-Through Curves	70-78		

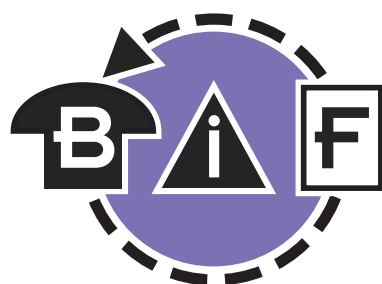

**Bussmann  
Information Fax ~  
636.527.1450**

**Get the latest, most up-to-date specification data on products listed in this catalog by calling Bussmann Information Fax.**

**BIF** is a simple to use automated fax response system. No need to wait for normal business hours; **BIF** is available around the clock for your convenience. All you need is a touch-tone telephone and a fax machine to get specification data when you want it.

A **BIF** document number is indicated with each product in this catalog. To get a detailed specification sheet simply call **636-527-1450** and follow the prompts. In a matter of minutes, a data sheet will be faxed to you. It's that simple!

**Bussmann Worldwide Web ~ <http://www.bussmann.com>**



# British Style BS 88

## Introduction

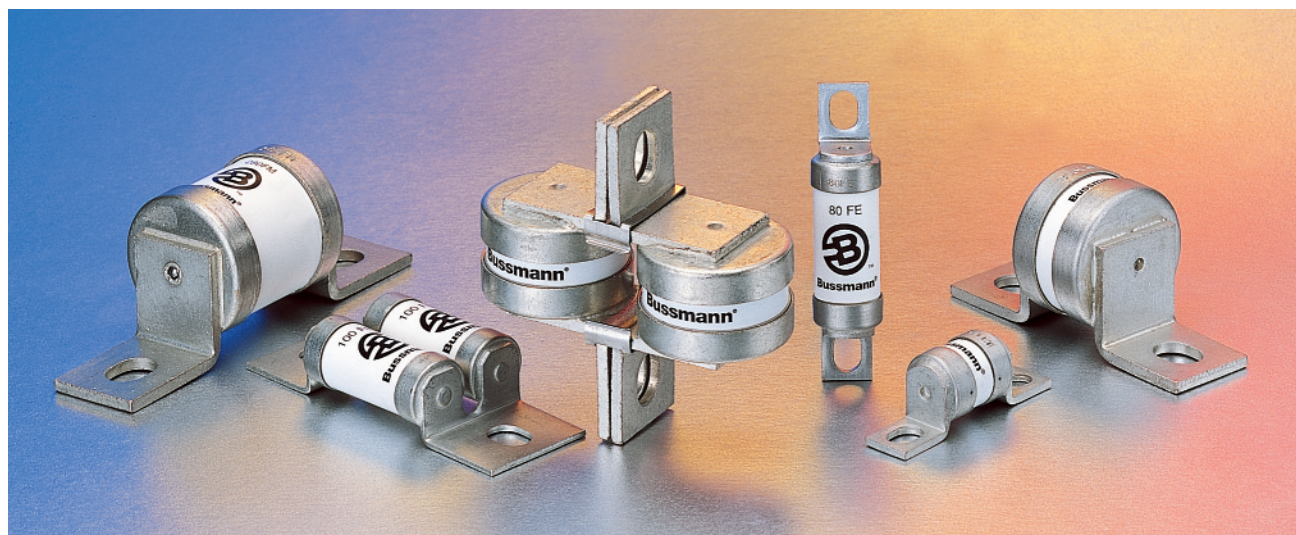

### Table of Contents

Fuse Style	Ampere Range	Page
240V	6-900A	80-81
690V	6-700A	82-83
<b>Accessories</b>		
Indicator System & Fuse Bases		84
<b>Curves</b>		
Time-Current & Peak Let-Through		85-89

### General Information

Designed and tested to:

- BS 88: Part 4
- IEC 269: Part 4
- U.L. Recognized

Bussmann offers the industry's widest range of British style semiconductor fuses and accessories.

Bussmann British style products use innovative arc quenching techniques and high grade materials to provide:

- Minimal energy let-through (I<sup>2</sup>t)
- Excellent DC performance
- Good surge withstand profile

British style fuses are typically found in equipment manufactured in the United Kingdom or British Commonwealth countries. However, North American manufacturers have begun to specify British style fuses — particularly in UPS applications at 240 volts or less — to take advantage of their size, performance and cost benefits.

#### Voltage Rating

All Bussmann British style fuses are tested to IEC 269: Part 4. This standard requires a test voltage which is 5% higher than the rated voltage. In North America, fuses are required to clear only their rated voltage.

#### Accessories

Trip-indicator fuses are available for use in parallel with the main fuse. Indicator fuses can be attached to the associated fuselink, or mounted separately in panel-mounted fuseclips. In addition, a push-on adaptor and microswitch attachment are available, to provide remote indication. Fuseblocks are also available for most applications.

Voltage	AC	DC	Ampere Range
240	X	—	6-900
150	—	X	6-900
690	X	—	6-700
500	—	X	6-700





# British Style BS 88 240V 6-900A



Type	Rated Current RMS-Amps	Electrical Characteristics				Ordering Information			Dimensions	Curves
		I <sup>2</sup> t (A <sup>2</sup> S)			Watts Loss	Part Number	Carton Qty.	Carton Weight (kg)	Figure Number	See Page or (Datasheet)
		Pre-arc	Clearing at 120V	Clearing at 240V						
LCT	6	2	6	9	1.0	6LCT	20	0.110	Fig. 1	page 85 (720101)
	10	3.8	12	22	2.5	10LCT				
	12	7	22	32	2.5	12LCT				
	16	20	50	100	2.5	16LCT				
	20	25	80	160	4.0	20LCT				
LET	25	18	120	250	4.0	25LET	10	0.310	Fig. 2	page 85 (720102)
	32	32	200	450	5.0	32LET				
	35	50	320	600	5.0	35LET				
	50	100	500	1400	7.0	50LET				
	63	180	1100	2200	9.0	63LET				
	80	300	1900	3800	10.0	80LET				
	100	600	3800	7500	10.0	100LET				
	125	600	3800	7500	16.0	125LET				
	160	1100	7000	16000	20.0	160LET				
180	1600	12000	29000	21.0	180LETa					
LMT	160	1100	7000	16000	17.0	160LMT	1	0.180	Fig. 3	page 86 (720103)
	200	1500	10000	20000	28.0	200LMT				
	250	3200	20000	40000	28.0	250LMT				
	315	6000	35000	75000	35.0	315LMT				
	355	8000	50000	100000	35.0	355LMT				
	400	14000	70000	160000	40.0	400LMT				
	450	18000	100000	220000	42.0	450LMT				
LMMT	400	6000	35000	80000	60.0	400LMMT	1	0.370	Fig. 4	page 86 (720104)
	500	14000	80000	170000	64.0	500LMMT				
	630	24000	150000	300000	75.0	630LMMT				
	710	32000	200000	460000	77.0	710LMMT				
	800	52000	300000	600000	82.0	800LMMT				
	900	75000	400000	800000	97.0	900LMMT				

- Interrupting rating 200kA RMS Symmetrical. ■ 150 Vdc rating
  - Watts loss provided at rated current.
  - Note: 7LET, 10LET, 12LET and 16LET are available for replacement purposes on existing equipment.
  - All fuses above have been tested at 318 Vac.
  - See accessories on page 84.
- 1 kg = 2.2 lbs 1 lb = 0.45 kg

## Dimensions

Fig. 1: LCT

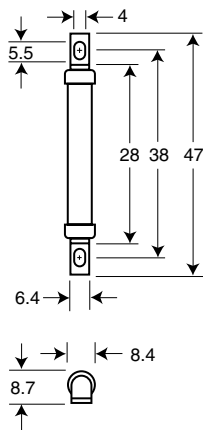
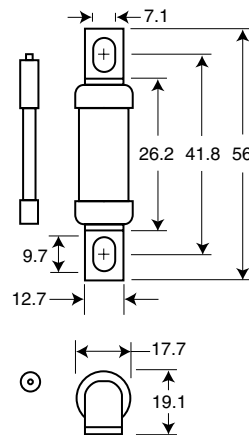

Fig. 2: LET



1mm = 0.0394" 1" = 25.4mm





# British Style BS 88 240V 6-900A



## Electrical Characteristics

### Total Clearing I<sup>2</sup>t

The total clearing I<sup>2</sup>t at rated voltage and at power factor of 15% are given in the electrical characteristics. For other voltages, the clearing I<sup>2</sup>t is found by multiplying by correction factor, K, given as a function of applied working voltage, E<sub>g</sub>, (RMS).

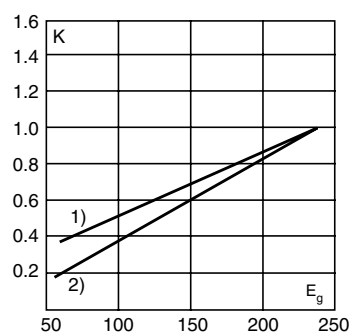

1) LCT  
2) LET, LMT, LMMT

### Arc Voltage

This curve gives the peak arc voltage, U<sub>L</sub>, which may appear across the fuse during its operation as a function of the applied working voltage, E<sub>g</sub>, (RMS) at a power factor of 15%.

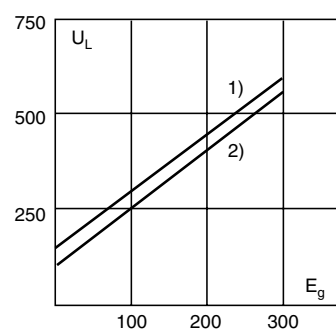

1) LCT  
2) LET, LMT, LMMT

### Power Losses

Watts loss at rated current is given in the electrical characteristics. The curve allows the calculation of the power losses at load currents lower than the rated current. The correction factor, K<sub>p</sub>, is given as a function of the RMS load current, I<sub>b</sub>, in % of the rated current.

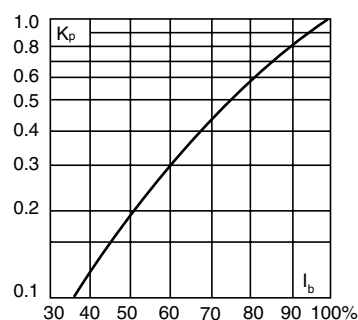

## Dimensions

Fig. 3: LMT

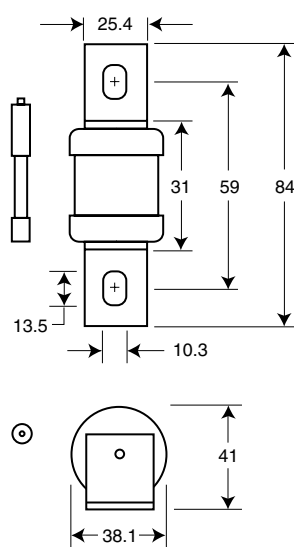
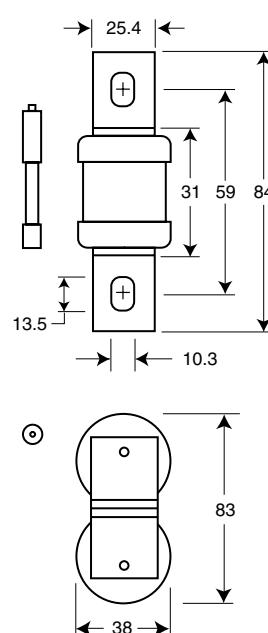

Fig. 4: LMMT



Indicator (Optional)

1mm = 0.0394" 1" = 25.4mm







# British Style BS 88 690V 6-700A



Type	Rated Current RMS-Amps	Electrical Characteristics				Ordering Information			Dimensions	Curves
		I <sup>2</sup> t (A <sup>2</sup> S)				Part Number	Carton Qty.	Carton Weight (kg)	Figure Number	See Page or (Datasheet)
		Pre-arc	Clearing at 415V	Clearing at 660V	Watts Loss					
CT	6	1.8	8.5	12	2	6CT	20	0.160	Fig. 1	page 87 (720105)
	10	7	30	48	3	10CT				
	12	10	40	65	3	12CT				
	16	16	66	110	7	16CT				
	20	32	150	220	7	20CT				
ET	25	25	150	250	7	25ET	10	0.420	Fig. 2	
	32	32	190	350	11	32ET				
	35	52	310	500	11	35ET				
	40	103	600	900	9	40ET				
	45	103	680	1100	11	45ET				
	56	135	950	1500	14	56ET				
	63	171	1200	2000	16	63ET				
	80	360	2500	4000	18	80ET				
FE	35	33	130	200	9	35FE	10	0.420	Fig. 2	page 88 (720106)
	40	52	180	300	9	40FE				
	45	76	270	450	11	45FE				
	50	103	380	600	11	50FE				
	63	135	480	750	12	63FE				
	71	210	600	950	17	71FE				
	80	250	900	1500	20	80FE				
	90	360	1300	2100	20	90FE				
	100	470	1800	2800	23	100FE				
	EET	90	490	3000	4500	19				
110		600	4000	6500	27	110EET				
140		1050	7000	12000	35	140EET				
160		1500	10000	17000	39	160EET				
FEE	100	400	1600	2400	24	100FEE	5	0.450	Fig. 3	page 89 (720108)
	120	540	1900	3100	32	120FEE				
	140	850	2500	3800	36	140FEE				
	160	1000	3700	5700	46	160FEE				
	180	1400	5300	8400	46	180FEE				
	200	1900	7100	11400	52	200FEE				
FM	180	1400	7500	13500	40	180FM	1	0.240	Fig. 4	page 88 (720109)
	200	2600	10500	18500	40	200FM				
	225	3700	14500	26500	44	225FM				
	250	5200	20500	37500	48	250FM				
	280	7000	30500	55000	48	280FM				
	315	10000	40000	77000	55	315FM				
	350	15000	60000	105000	55	350FM				
FMM	400	10000	40000	72500	85	400FMM	1	0.450	Fig. 5	page 89 (720110)
	450	15000	60000	105000	90	450FMM				
	500	20000	82000	150000	100	500FMM				
	550	30000	120000	215000	100	550FMM				
	630	45000	180000	310000	100	630FMM				
	700	60000	245000	420000	120	700FMM				
MT†	160	2400	15000	25000	26	160MT	1	0.260	Fig. 4	page 87 (720111)
	180	3800	25000	38000	26	180MT				
	200	6000	40000	58000	27	200MT				
	250	11500	80000	110000	32	250MT				
	280	16500	100000	150000	35	280MT				
	315	19000	125000	180000	42	315MT				
	355	22000	160000	200000	51	355MT				
	MMT†	180	1650	12000	18000	42				
200		2200	16000	23000	42	200MMT				
225		3700	26000	40000	42	225MMT				
280		6600	47000	70000	47	280MMT				
315		8600	62000	91000	51	315MMT				
355		13500	97000	140000	54	355MMT				
400		21000	150000	220000	60	400MMT				
450		30000	220000	320000	57	450MMT				
500		42000	300000	450000	64	500MMT				
560		60000	430000	640000	64	560MMT				
630		68500	500000	720000	86	630MMT				
710		78000	600000	850000	105	710MMT				

■ Interrupting rating 200kA RMS Symmetrical. ■ 500 Vdc rating

■ Watts loss provided at rated current.

■ Note: FC, 8ET, 12ET, 15ET, 20ET, 65EET and 75EET are available for replacement purposes on existing equipment.

■ See accessories on page 84.

†350 Vdc (IEC) rating. Consult Bussmann for U.L. Recognition status.

1 kg = 2.2 lbs 1 lb = 0.45 kg





# British Style BS 88 690V 6-700A



## Electrical Characteristics

### Total Clearing I<sup>2</sup>t

The total clearing I<sup>2</sup>t at rated voltage and at power factor of 15% are given in the electrical characteristics. For other voltages, the clearing I<sup>2</sup>t is found by multiplying by correction factor, K, given as a function of applied working voltage, E<sub>g</sub>, (RMS).

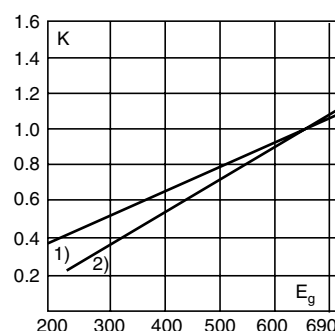

1) CT, ET, EET, FE, FEE, MT, MMT  
2) FM, FMM

### Arc Voltage

This curve gives the peak arc voltage, U<sub>L</sub>, which may appear across the fuse during its operation as a function of the applied working voltage, E<sub>g</sub>, (RMS) at a power factor of 15%.

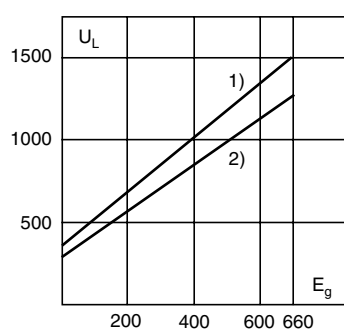

1) CT  
2) ET, FE, EET, FEE, FM, FMM

### Power Losses

Watts loss at rated current is given in the electrical characteristics. The curve allows the calculation of the power losses at load currents lower than the rated current. The correction factor, K<sub>p</sub>, is given as a function of the RMS load current, I<sub>b</sub>, in % of the rated current.

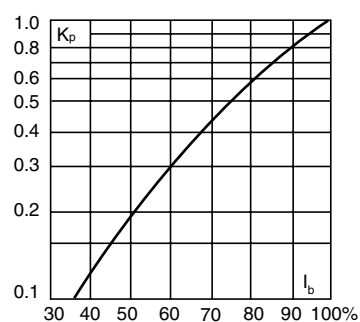

## Dimensions

Fig. 1: CT

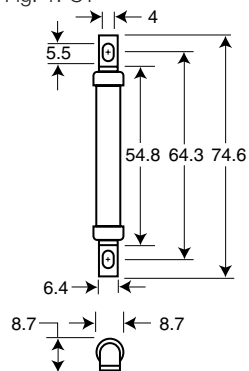

Fig. 2: ET, FE

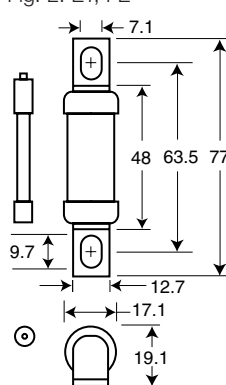

Fig. 3: EET, FEE

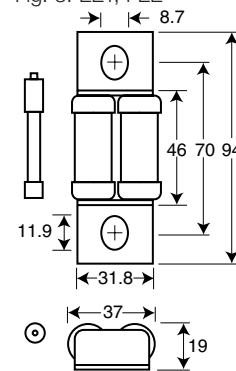

Fig. 4: FM, MT

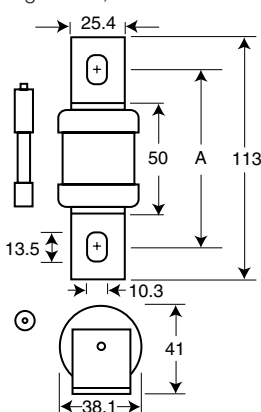
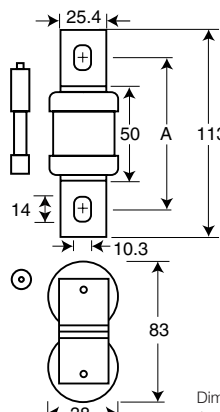

Fig. 5: FMM, MMT



Type	"A" Dimension
FM	80-85
FMM	80-85
MT	85
MMT	85

Dimensions in mm.  
1mm = 0.0394" 1" = 25.4mm







**British Style BS 88 - Accessories**

**Indicator System and Fuse Bases (Blocks)**



Trip-indicator fuselinks are available for use in parallel with the main fuselinks. They can either be attached to the associated fuselink or mounted separately in panel mounted fuse clips, Part No. CL1. A push-on adaptor and microswitch attachment is available for use with the trip indicator to give the facility of remote indication, reference MAI or MBI.

Fuse ratings of 20A and below cannot usually accommodate a trip fuselink in parallel.

Where trip indicator fuselinks are to be attached to the main fuselink, an accessory pack comprising a pair of mounting clips and an appropriate trip indicator fuselink will be required.

The ordering code references for these packs are listed below:

Fuse Type	Order Ref.	Fuse Type	Order Ref.
ET	EC-600	FM	MC-600
EET	EC-600	FMM	MC-600
FE	EC-600	LMT	MC-250
FEE	EC-600	LMMT	MC-250
LET	EC-250		

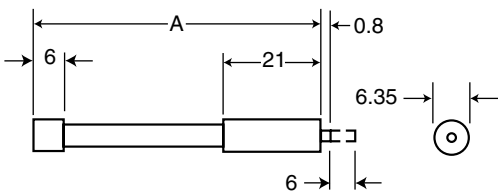

Dimensions in mm.  
1mm = 0.0394" 1" = 25.4mm

**Trip-indicator Fuselink Data**

Type	Dim. 'A' Max.	Voltage Rating	Type	Dim. 'A' Max.	Voltage Rating
Ti250	37.6	250	Ti1100	98.4	1100
Ti500	47.5	500	Ti1500	120.8	1500
Ti600	55.7	600	Ti2000	147.5	2000
Ti700	61.8	700	Ti2500	198.3	2500

BIF document: 720037

**Microswitch and Adaptor Type MAI**

Current Rating:	
AC 50/60Hz resistive load @ 250 VRMS	4A
AC 50/60Hz resistive load @ 127 VRMS	6A
DC, resistive load @ 110 Vdc	0.7
DC, resistive load @ 30 Vdc	2
Maximum Working Voltage:	
Contact-to-contact (RMS)	1000V
Contact-to-contact (RMS)	1500V

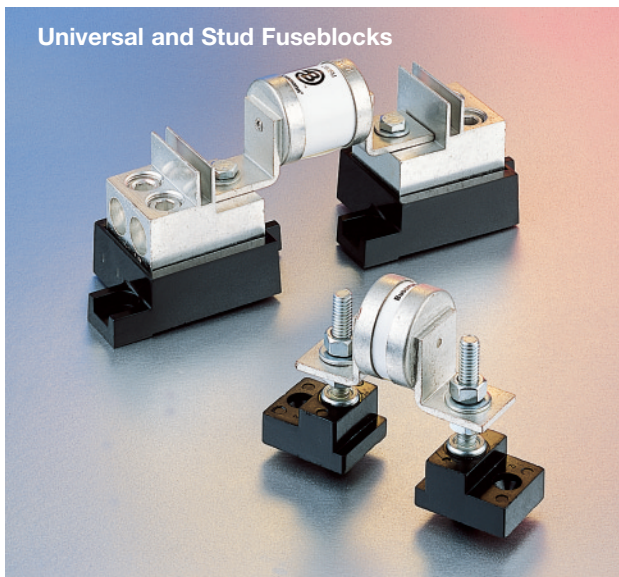
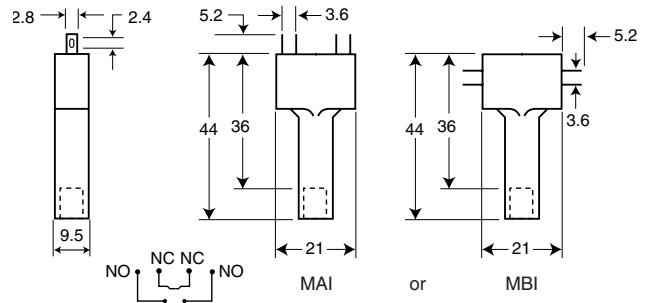

**Stud Fuseblocks**

Part No.	Stud Height	Stud Dia. & Threads
C5268-1	1.00"	5/16-18
C5268-2	1.75"	5/16-18
C5268-3	0.75"	5/16-18
C5268-4	1.00"	1/4-20
C5268-5	1.75"	1/4-20

**Universal Fuseblocks**

Modular Base	Max. Voltage	Max. Fuse Current Rating	BIF Document
1BS101	600V	100A	1206
1BS102	600V	400A	1207
1BS103	600V	400A	1208
1BS104	600V	600A	1209





# British Style BS 88 Curves

## LCT 6-20: 240V Time-Current Curve

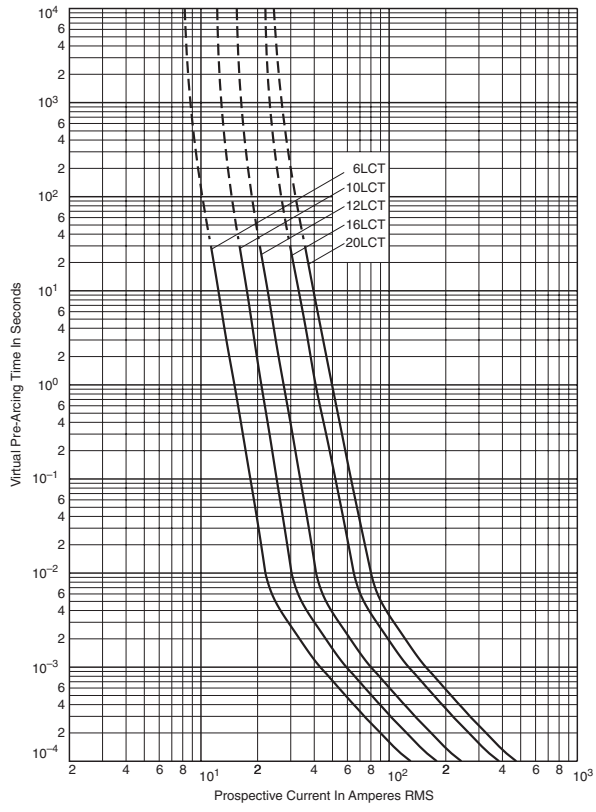

## LET 25-180: 240V Time-Current Curve

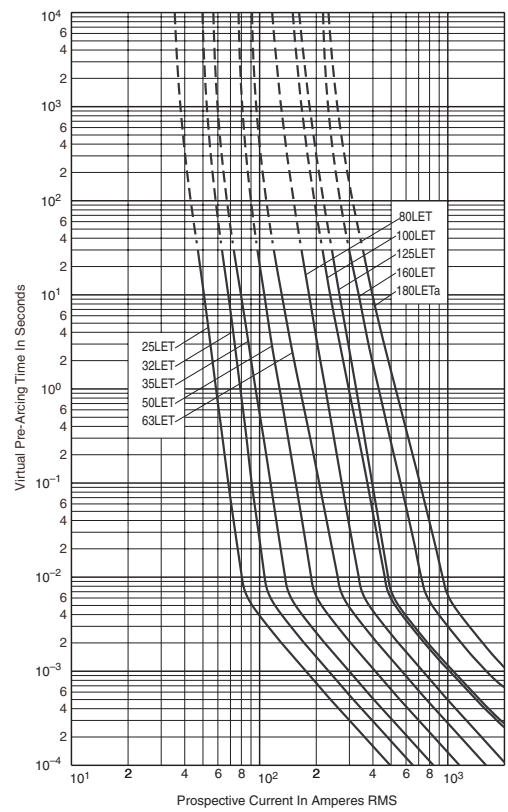

## Peak Let-Through Curve

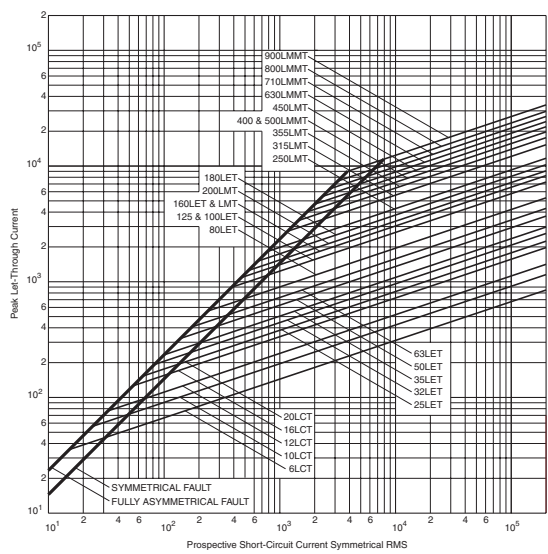

## Peak Let-Through Curve

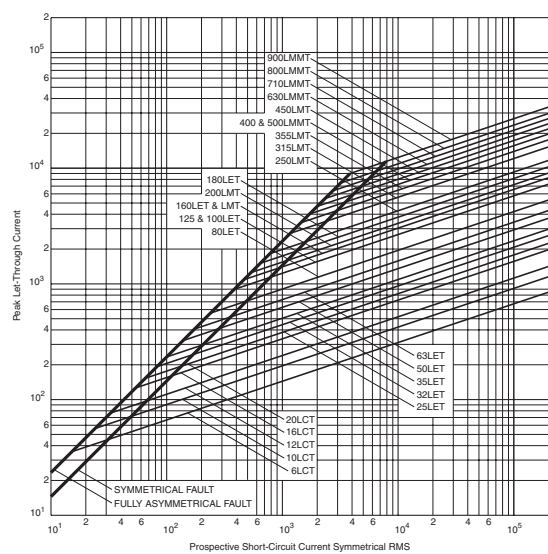

BIF document: 35785296

BIF document: 35785293



For complete specification data, visit our Web site at [www.bussmann.com](http://www.bussmann.com)  
or call Bussmann Information Fax ~ 636.527.1450



**British Style BS 88  
Curves**

**LMT 160-450: 240V  
Time-Current Curve**

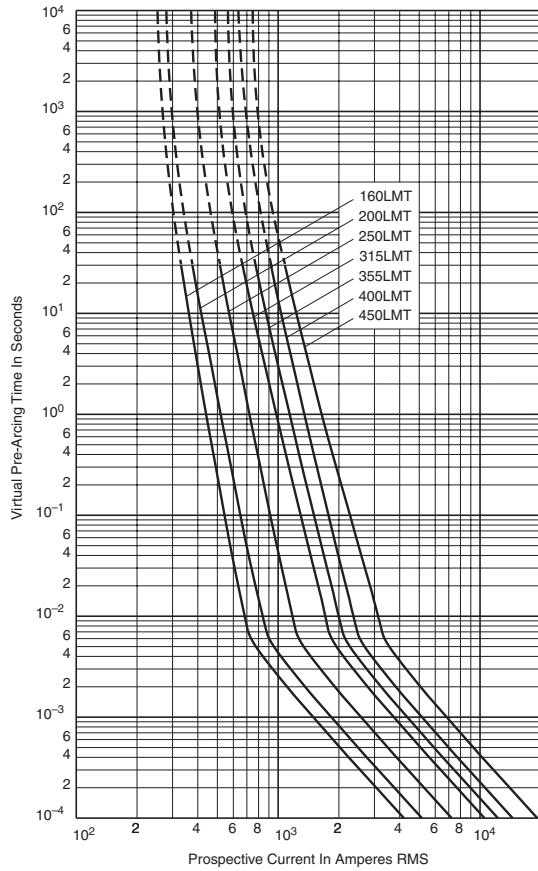

**Peak Let-Through Curve**

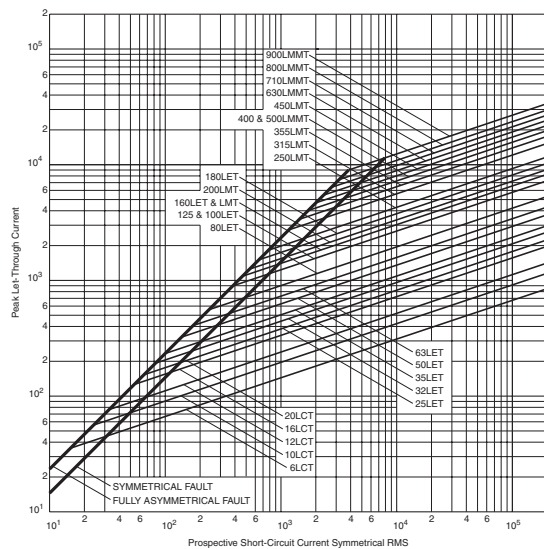

**BIF document: 35785294**

**LMMT 400-900: 240V  
Time-Current Curve**

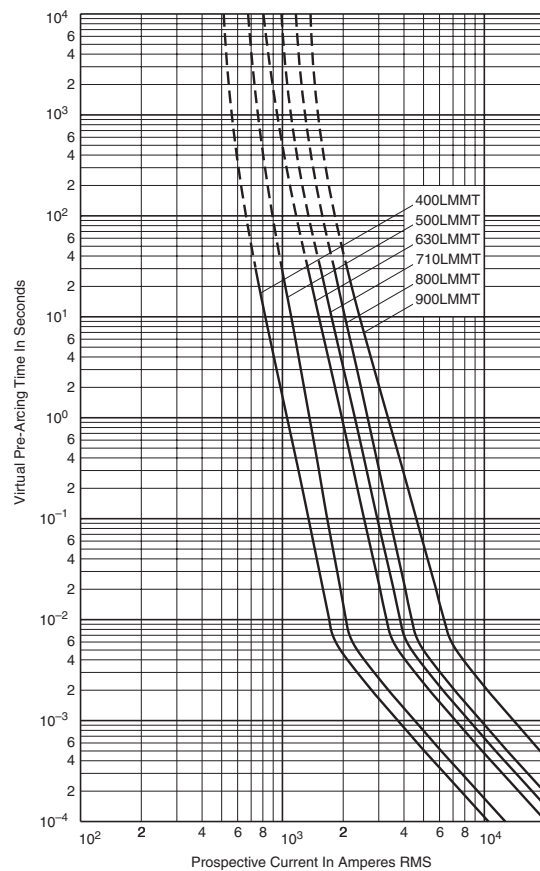

**Peak Let-Through Curve**

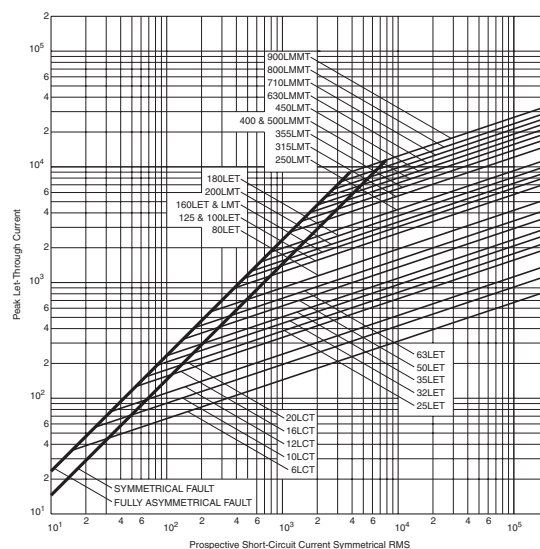

**BIF document: 35785295**





# British Style BS 88 Curves

## CT 6-20, ET 25-80: 690V Time-Current Curve

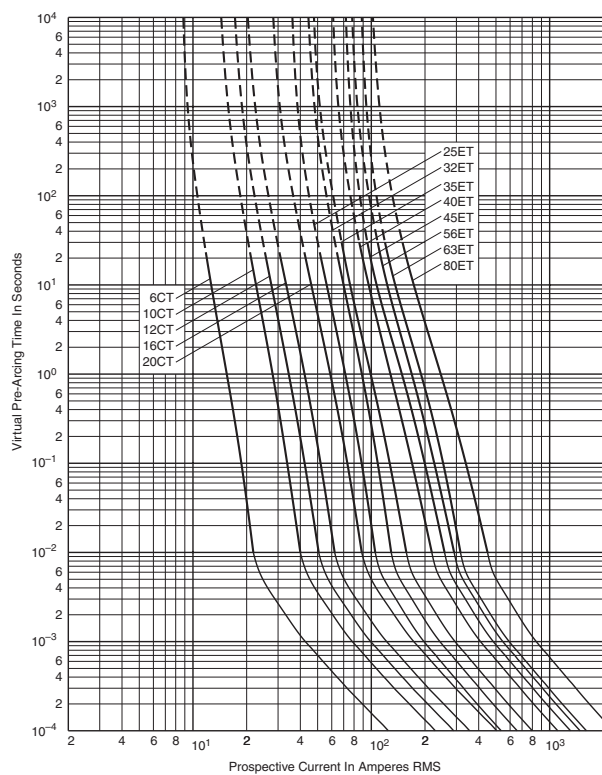

## EET 90-160, MT 160-355: 690V Time-Current Curve

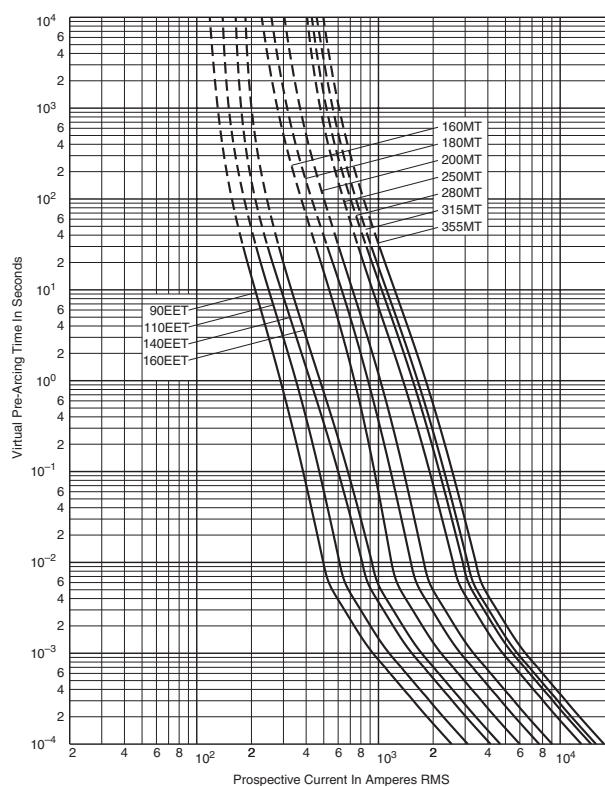

## Peak Let-Through Curve

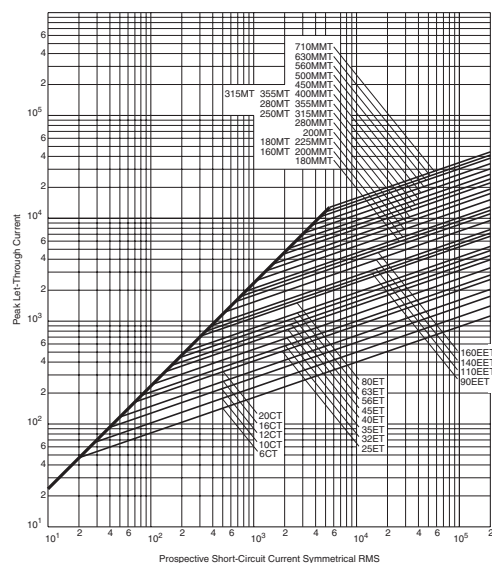

## Peak Let-Through Curve

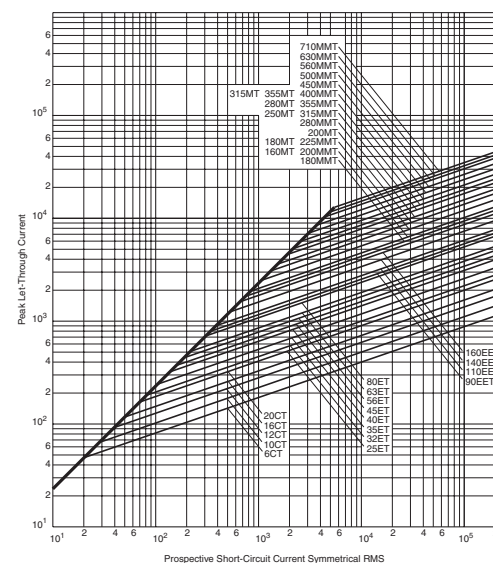

BIF document: 35785312

BIF document: 35785313







**British Style BS 88**

**Curves**

**MMT 180-710: 690V**

**Time-Current Curve**

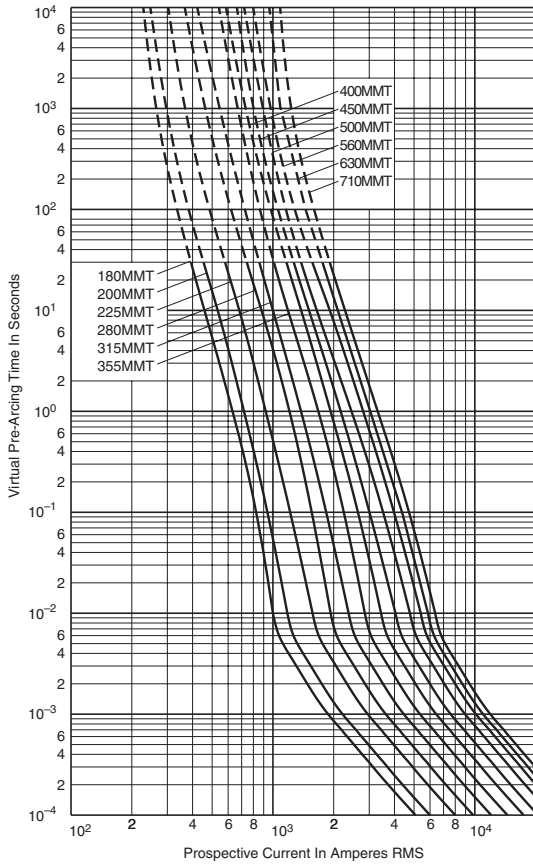

**Peak Let-Through Curve**

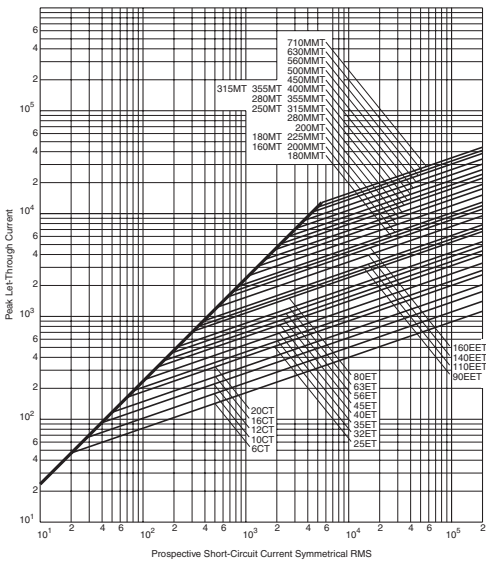

**BIF document: 35785311**

**FE 35-100 & FM 180-350: 690V**

**Time-Current Curve**

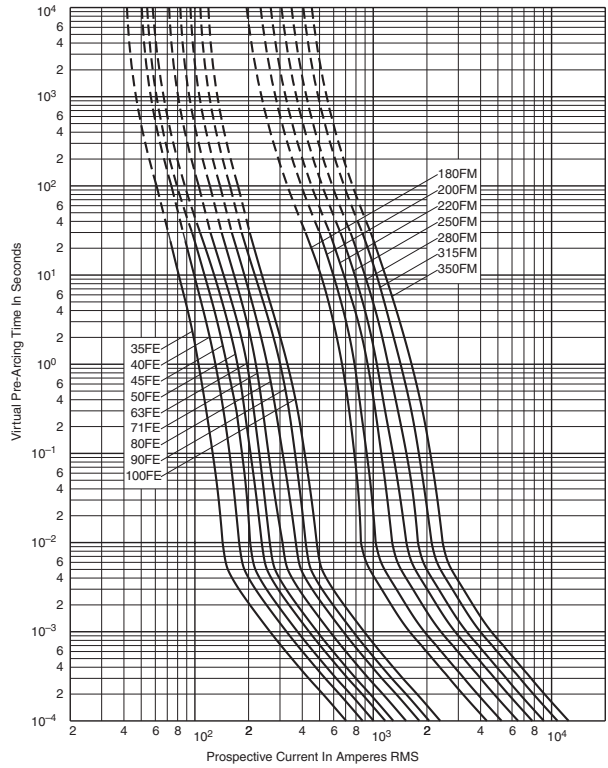

**Peak Let-Through Curve**

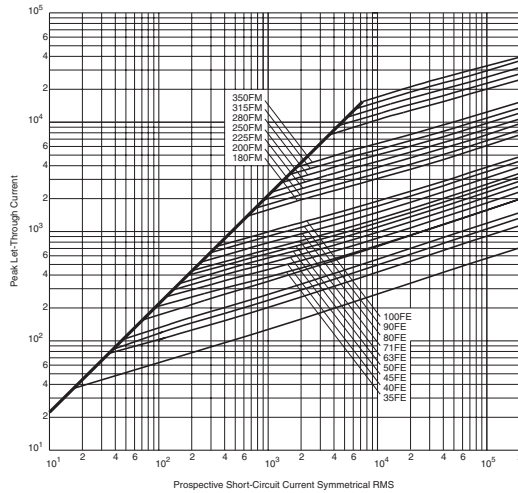

**BIF document: 35785314**





# British Style BS 88 Curves

## FEE 100-200 & FMM 400-700: 690V Time-Current Curve

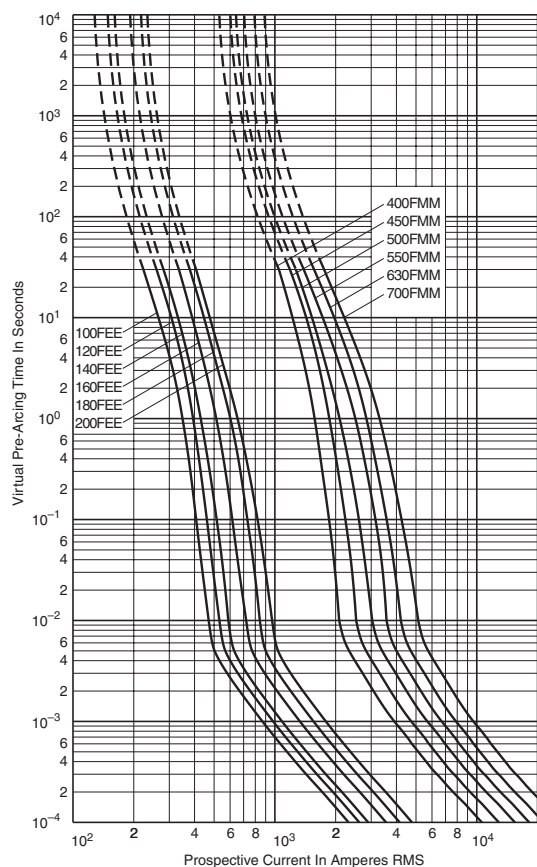



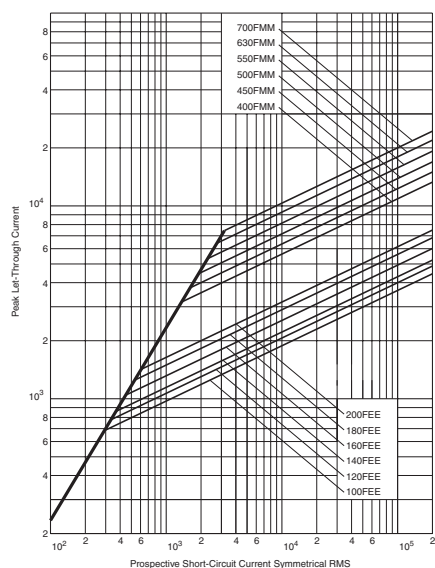

## Peak Let-Through Curve



BIF document: 35785292



## Table of Contents

<b>General Applications</b>	<b>2-4</b>		
 <b>North American</b>	<b>5</b>	 <b>British BS 88</b>	<b>79</b>
FWA 130V 1000-4000A	6-7	240V 6-900A	80-81
FWA 150V 70-1000A	8-9	690V 6-700A	82-83
FWX 250V 35-2500A	10-11	Accessories	84
FWH 500V 35-1600A	12-13	Time-Current & Peak Let-Through Curves	85-89
KAC 600V 1-1000A	14		
KBC 600V 35-800A	15	 <b>Ferrule</b>	<b>91</b>
FWP 700V 5-1200A	16-17	FWA 150V 5-60A	92
FWJ 1000V 35-2000A	18-19	FWX 250V 1-30A	93
Accessories	20	FWH 500V 0.25-30A	94-95
Time-Current & Peak Let-Through Curves	21-26	FWC 600V 6-32A	96
		FWP 660V/700V 1-100A	97-98
 <b>Square Body</b>	<b>27</b>	FWK 750V 5-60A	99
Applications	28-29	FWJ 1000V 20-30A	100
DIN 43 653	30-43	FWL/FWS 1250/1500/2000V 2-30A	101
DIN 43 620	44-49	Accessories	102
Flush End Contact	50-59	Time-Current & Peak Let-Through Curves	103-108
French Style	60-61		
US Style	62-67		
Accessories	68-69		
Time-Current & Peak Let-Through Curves	70-78		

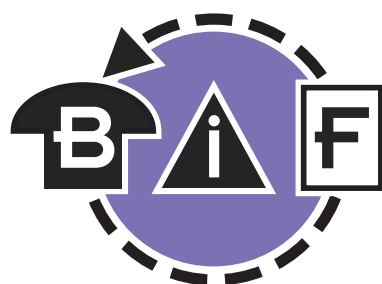

**Bussmann  
Information Fax ~  
636.527.1450**

**Get the latest, most up-to-date specification data on products listed in this catalog by calling Bussmann Information Fax.**

**BIF** is a simple to use automated fax response system. No need to wait for normal business hours; **BIF** is available around the clock for your convenience. All you need is a touch-tone telephone and a fax machine to get specification data when you want it.

A **BIF** document number is indicated with each product in this catalog. To get a detailed specification sheet simply call **636-527-1450** and follow the prompts. In a matter of minutes, a data sheet will be faxed to you. It's that simple!

**Bussmann Worldwide Web ~ <http://www.bussmann.com>**



# Ferrule

## Introduction



### Table of Contents

Catalog Symbol	Ampere Range	Page
FWA 150V	5-60A	92
FWX 250V	1-50A	93
FWH 500V	0.25-30A	94-95
FWC 600V	6-32A	96
FWP 660V/700V	1-100A	97-98
FWK 750V	5-60A	99
FWJ 1000V	20-30A	100
FWL/FWS 1250V/1500V/2000V	2-30A	101
<b>Accessories</b>		
Fuseholders		102
<b>Curves</b>		
Time-Current & Peak Let-Through		103-108

Voltage	AC	DC	Ampere Range
150	X	X	5-60
250	X	X	1-50
500	X	X	0.25-30
600	X	X (400 Vdc)	6-32
700	X	—	1-100
700	X	X	1-50
750	X	X	5-60
1000	X	X (800 Vdc)	20-30
1250	X	X (1000 Vdc)	20-30
1500	X	X (1000 Vdc)	8-15
2000	X	X (1000 Vdc)	2-6

### General Information

Select fuses designed and tested to:

- IEC 269: Part 4
- U.L. Recognized

Bussmann offers a full line of ferrule style (cylindrical and clip-mounted) fuses, designed and tested to meet standards and requirements in various locations around the world. Their unique design and construction provide:

- Superior cycling capability
- Low energy let-through (I<sup>2</sup>t)

Ferrule fuses provide an excellent solution for small UPS, small AC drives and other low power applications where space is at a premium.

#### Voltage Rating

All Bussmann ferrule fuses — except 660 volt — have been tested at their rated voltage. The 660 volt ferrule fuse has been tested to the IEC 269 standard, which requires clearing at the rated voltage +10%.

#### Accessories

Ferrule fuses may be mounted in fuseclips, fuseholders, fuseblocks or fused switches. A variety of products are available to suit most end-use requirements.







# Ferrule FWA 150V 5-60A



Size	Rated Current RMS-Amps	I <sup>2</sup> t (A <sup>2</sup> S)		Watts Loss	Ordering Information			Dimensions Figure Number	Curves See Page
		Pre-arc	Clearing at 150V		Part Number	Carton Qty.	Carton Weight (kg)		
10 × 38mm (1 <sup>3</sup> / <sub>32</sub> "	5	1.6	8	1	FWA-5A10F	10	0.100	Fig. 1	page 103
	10	3.6	16	2.7	FWA-10A10F				
	15	14	55	3.3	FWA-15A10F				
	20	33	130	3.8	FWA-20A10F				
	25	58	220	4.9	FWA-25A10F				
	30	100	400	4.9	FWA-30A10F				
21 × 51mm (1 <sup>1</sup> / <sub>16</sub> "	35	75	800	4.5	FWA-35A21F	10	0.600	Fig. 1	page 103
	40	100	1000	5.1	FWA-40A21F				
	45	130	1300	6	FWA-45A21F				
	50	170	1600	7.3	FWA-50A21F				
	55	210	1900	8.0	FWA-55A21F				
	60	250	2400	8.0	FWA-60A21F				

- Interrupting rating 100kA RMS Symmetrical.
- 150 Vdc U.L. Recognition.
- Watts loss provided at rated current.

1 kg = 2.2 lbs. 1 lb = 0.45 kg

## Dimensions

Fig. 1: 5-60 Amp Range

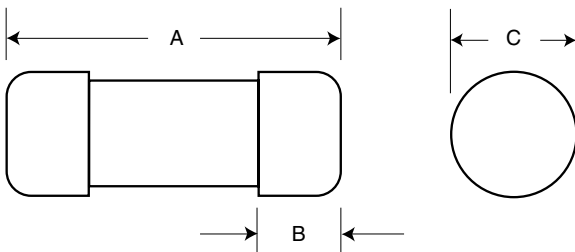

Part Number	Metric			Inches		
	A	B	C	A	B	C
FWA 5A10F-30A10F	38.1	9.5	10.3	1.5	0.375	0.406
FWA 35A21F-60A21F	50.8	15.9	20.6	2.0	0.625	0.811

Dimension in mm.  
1mm = 0.0394" 1" = 25.4mm

## Electrical Characteristics

### Total Clearing I<sup>2</sup>t

The total clearing I<sup>2</sup>t at rated voltage and at power factor of 15% are given in the electrical characteristics. For other voltages, the clearing I<sup>2</sup>t is found by multiplying by correction factor, K, given as a function of applied working voltage, E<sub>g</sub>, (RMS).

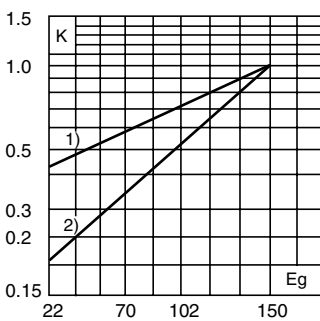

1) 5-30 Amp Range  
2) 35-60 Amp Range

### Arc Voltage

This curve gives the peak arc voltage, U<sub>L</sub>, which may appear across the fuse during its operation as a function of the applied working voltage, E<sub>g</sub>, (RMS) at a power factor of 15%.

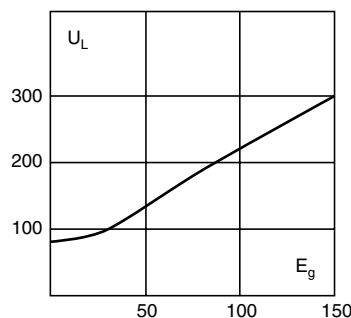

### Power Losses

Watts loss at rated current is given in the electrical characteristics. The curve allows the calculation of the power losses at load currents lower than the rated current. The correction factor, K<sub>p</sub>, is given as a function of the RMS load current, I<sub>b</sub>, in % of the rated current.

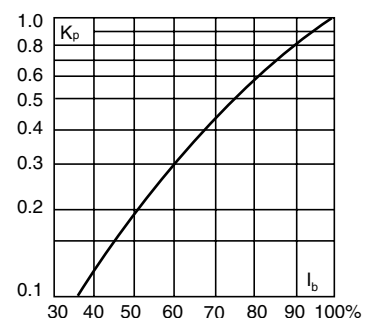

BIF document: 720003





# Ferrule FWX 250V (U.L.) 1-30A



Electrical Characteristics				Ordering Information			Dimensions	Curves	
Size	Rated Current RMS-Amps	I <sup>2</sup> t (A <sup>2</sup> S)		Watts Loss	Part Number	Carton Qty.	Carton Weight (kg)	Figure Number	See Page
		Pre-arc	Clearing at 250V						
14 × 51mm ( <sup>9</sup> / <sub>16</sub> "	1	—	—	—	FWX-1A14F	10	0.225	Fig. 1	page 104
	2	—	—	—	FWX-2A14F				
	3	—	—	—	FWX-3A14F				
	4	—	—	—	FWX-4A14F				
	5	1.6	13	1.3	FWX-5A14F				
	10	3.6	24	3.4	FWX-10A14F				
	15	14	83	3.8	FWX-15A14F				
	20	33	200	4.6	FWX-20A14F				
	25	58	300	5.3	FWX-25A14F				
	30	100	500	5.9	FWX-30A14F				
50	200	1800	5.7	FWX-50A14F					

- Interrupting rating 200kA RMS Symmetrical.
  - Watts loss provided at rated current.
  - (250 Vdc/Interrupting rating 50kA) U.L. Recognition on 5 through 30 amperes only. Consult Bussmann for additional ratings.
  - See accessories on page 102.
- 1 kg = 2.2 lbs. 1 lb = 0.45 kg

## Dimensions

Fig. 1: 1-50 Amp Range

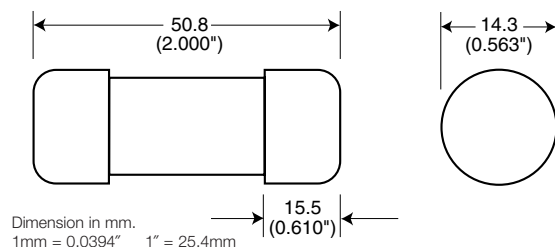

## Electrical Characteristics

### Total Clearing I<sup>2</sup>t

The total clearing I<sup>2</sup>t at rated voltage and at power factor of 15% are given in the electrical characteristics. For other voltages, the clearing I<sup>2</sup>t is found by multiplying by correction factor, K, given as a function of applied working voltage, E<sub>g</sub>, (RMS).

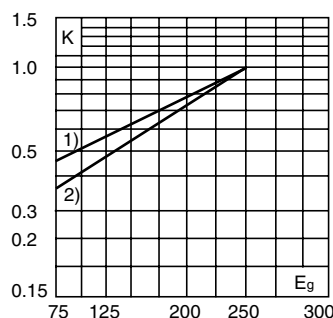

### Arc Voltage

This curve gives the peak arc voltage, U<sub>L</sub>, which may appear across the fuse during its operation as a function of the applied working voltage, E<sub>g</sub>, (RMS) at a power factor of 15%.

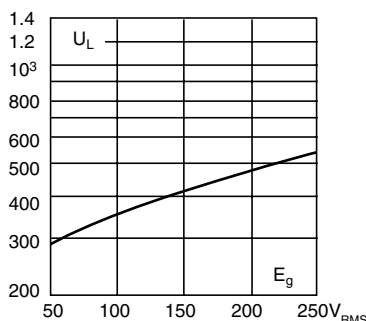

### Power Losses

Watts loss at rated current is given in the electrical characteristics. The curve allows the calculation of the power losses at load currents lower than the rated current. The correction factor, K<sub>p</sub>, is given as a function of the RMS load current, I<sub>b</sub>, in % of the rated current.

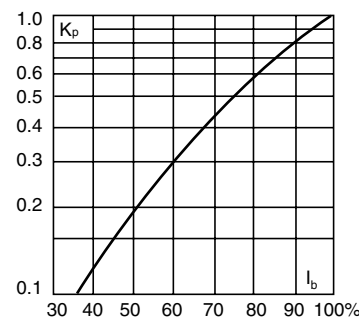



# Ferrule FWH 500V 0.25-30A



Electrical Characteristics				Ordering Information			Dimensions	Curves	
Size	Rated Current RMS-Amps	I <sup>2</sup> t (A <sup>2</sup> S)		Watts Loss	Part Number	Carton Qty.	Carton Weight (kg)	Figure Number	See Page
		Pre-arc	Clearing at 500V						
6 × 32mm (¼" × 1¼")	0.25	0.01	0.05	2.7	FWH-.250A6F	10	0.03	Fig. 1	page 104
	0.5	0.05	0.25	1.2	FWH-.500A6F				
	1	0.4	2	1.7	FWH-001A6F				
	2	1.3	3.5	3.2	FWH-002A6F				
	3.15	3.1	7.7	2.9	FWH-3.15A6F				
	5	15	40	2.1	FWH-005A6F				
	6.3	36	90	2.3	FWH-6.30A6F				
	7	50	125	2.5	FWH-007A6F				
	10	19	51	—	FWH-010A6F				
	12.5	20	60	3.53	FWH-12.5A6F				
	15	44	146	3.08	FWH-015A6F				
	16	48	177	4.48	FWH-016A6F				
	20	75	259	4.26	FWH-020A6F				
	25	126	345	—	FWH-025A6F				
	30	145	430	—	FWH-030A6F				

- 0.25-7A 300% minimum opening current at rated voltage.
- 10-30A 200% minimum opening current at rated voltage.

1 kg = 2.2 lbs. 1 lb = 0.45 kg

- Interrupting rating: 0.25-20A 50kA at ≥ 20% pf 25-30A 20kA at ≥ 20% pf.
- Consult Bussmann for DC ratings.
- See accessories on page 102.

### Opening Times

Current Ratings	150%	200%	300%
0.25A -7A	> 30 min.	< 30 min.	≤ 10 sec.
10-30A	< 30 min.	< 30 min.	≤ 10 sec.

### Dimensions

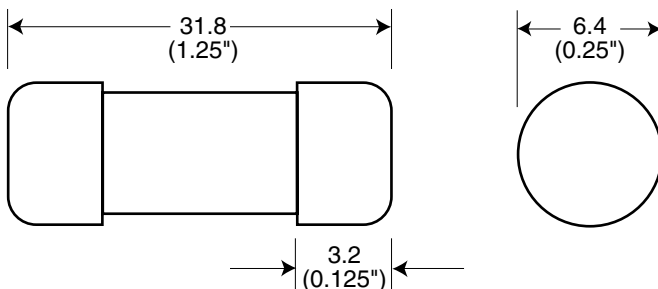

Dimension in mm.  
1mm = 0.0394" 1" = 25.4mm





# Ferrule FWH 500V 1-30A



Electrical Characteristics				Ordering Information			Dimensions	Curves	
Size	Rated Current RMS-Amps	I <sup>2</sup> t (A <sup>2</sup> S)		Watts Loss	Part Number	Carton Qty.	Carton Weight (kg)	Figure Number	See Page
		Pre-arc	Clearing at 500V						
14 × 51mm ( <sup>9</sup> / <sub>16</sub> "	1	—	—	—	FWH-1A14F	10	0.250	Fig. 1	page 105
	2	—	—	—	FWH-2A14F				
	3	—	—	2.3	FWH-3A14F				
	4	—	—	—	FWH-4A14F				
	5	1.6	6.4	1.5	FWH-5A14F				
	6	1.6	6.4	1.5	FWH-6A14F				
	10	3.6	13	4	FWH-10A14F				
	12	—	—	—	FWH-12A14F				
	15	10	40	5.5	FWH-15A14F				
	20	26	96	6	FWH-20A14F				
25	49	191	7	FWH-25A14F					
30	58	232	9	FWH-30A14F					

- Interrupting rating 200kA RMS Symmetrical. 1 kg = 2.2 lbs. 1 lb = 0.45 kg
- Watts loss provided at rated current.
- (500 Vdc/Interrupting rating 50kA) U.L. Recognition on 5 through 30 amperes only. Consult Bussmann for additional ratings.
- CSA Component Acceptance: 5 - 30A 
- See accessories on page 102.

## Dimensions

Fig. 1: 1-30 Amp Range

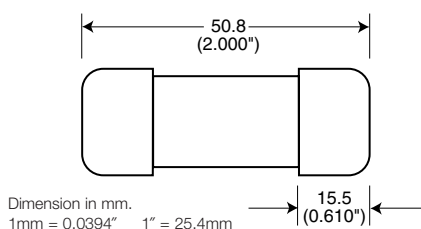

## Electrical Characteristics

### Total Clearing I<sup>2</sup>t

The total clearing I<sup>2</sup>t at rated voltage and at power factor of 15% are given in the electrical characteristics. For other voltages, the clearing I<sup>2</sup>t is found by multiplying by correction factor, K, given as a function of applied working voltage, E<sub>g</sub>, (RMS).

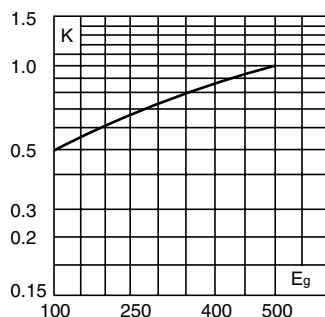

### Arc Voltage

This curve gives the peak arc voltage, U<sub>L</sub>, which may appear across the fuse during its operation as a function of the applied working voltage, E<sub>g</sub>, (RMS) at a power factor of 15%.

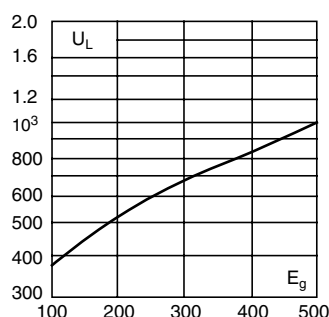

### Power Losses

Watts loss at rated current is given in the electrical characteristics. The curve allows the calculation of the power losses at load currents lower than the rated current. The correction factor, K<sub>p</sub>, is given as a function of the RMS load current, I<sub>b</sub>, in % of the rated current.

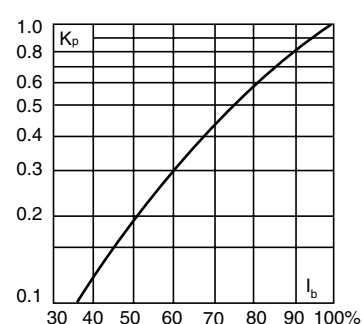



# Ferrule FWC 600V 6-32A



Electrical Characteristics				Ordering Information			Dimensions	Curves	
Size	Rated Current RMS-Amps	I <sup>2</sup> t (A <sup>2</sup> S)		Watts Loss	Part Number	Carton Qty.	Carton Weight (kg)	Figure Number	See Page
		Pre-arc	Clearing at 600V						
10 x 38mm (1 1/2")	6	4	30	1.5	FWC-6A10F	10	0.100	Fig. 1	page 106
	8	6	50	2.0	FWC-8A10F				
	10	9	70	2.5	FWC-10A10F				
	12	15	120	3.0	FWC-12A10F				
	16	25	150	3.5	FWC-16A10F				
	20	34	260	4.8	FWC-20A10F				
	25	60	390	6.0	FWC-25A10F				
32	95	600	7.5	FWC-32A10F					

- Interrupting rating 200kA RMS Symmetrical.
- Watts loss provided at rated current.
- (400 Vdc/Interrupting rating 50kA) U.L. Recognition: 32A
- (700 Vdc/Interrupting rating 50kA) U.L. Recognition: 6 - 25A
- See accessories on page 102.

1 kg = 2.2 lbs. 1 lb = 0.45 kg

## Dimensions

Fig. 1: 6-32 Amp Range

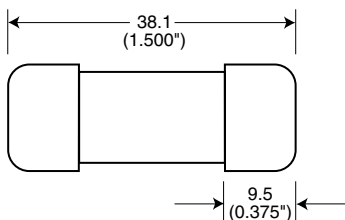

Dimension in mm.  
1mm = 0.0394" 1" = 25.4mm

## Electrical Characteristics

### Total Clearing I<sup>2</sup>t

The total clearing I<sup>2</sup>t at rated voltage and at power factor of 15% are given in the electrical characteristics. For other voltages, the clearing I<sup>2</sup>t is found by multiplying by correction factor, K, given as a function of applied working voltage, E<sub>g</sub>, (RMS).

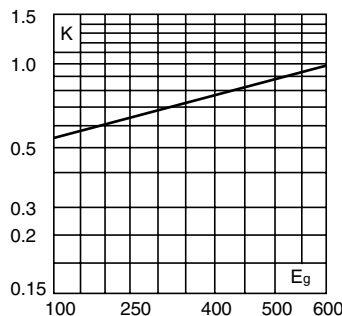

### Arc Voltage

This curve gives the peak arc voltage, U<sub>L</sub>, which may appear across the fuse during its operation as a function of the applied working voltage, E<sub>g</sub>, (RMS) at a power factor of 15%.

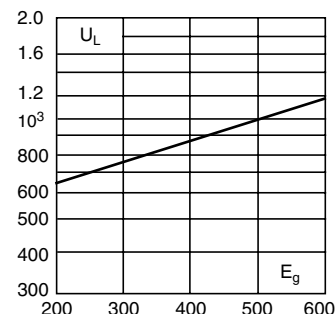

### Power Losses

Watts loss at rated current is given in the electrical characteristics. The curve allows the calculation of the power losses at load currents lower than the rated current. The correction factor, K<sub>p</sub>, is given as a function of the RMS load current, I<sub>b</sub>, in % of the rated current.

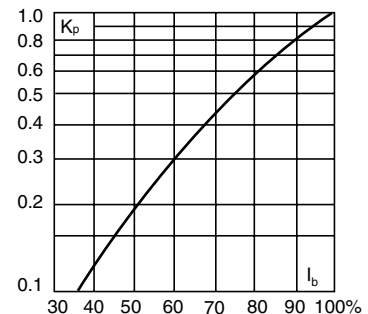



# Ferrule FWP 660V/700V (IEC/U.L.) 1-50A



Size	Electrical Characteristics			Watts Loss	Ordering Information			Dimensions Figure Number	Curves See Page
	Rated Current RMS-Amps	I <sup>2</sup> t (A <sup>2</sup> S)			Part Number	Carton Qty.	Carton Weight (kg)		
		Pre-arc	Clearing at 660V						
14 × 51mm ( <sup>9</sup> / <sub>16</sub> "	1	—	—	—	FWP-1A14F	10	0.225	Fig. 1	page 106
	2	—	—	—	FWP-2A14F				
	3	—	—	—	FWP-3A14F				
	4	—	—	—	FWP-4A14F				
	5	1.6	11	1.5	FWP-5A14F				
	6	—	—	—	FWP-6A14F				
	10	3.6	22	4	FWP-10A14F				
	15	10	75	5.5	FWP-15A14F				
	20	26	180	6	FWP-20A14F				
	25	44	320	7	FWP-25A14F				
	30	58	450	9	FWP-30A14F				
32	68	600	7.6	FWP-32A14F					
40	84	750	8	FWP-40A14F					
50	200	1800	9	FWP-50A14F					

- Interrupting rating 200kA RMS Symmetrical.
- Watts loss provided at rated current.
- (700 Vdc/Interrupting rating 50kA) U.L. Recognition.
- CSA Component Acceptance: 5 - 30A.

1 kg = 2.2 lbs. 1 lb = 0.45 kg



## Dimensions

Fig. 1: 1-50 Amp Range

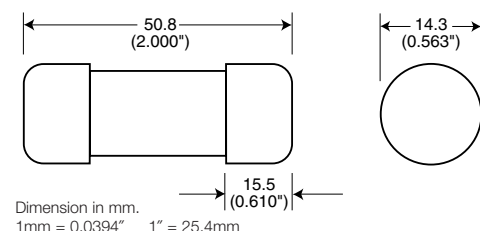

## Electrical Characteristics

### Total Clearing I<sup>2</sup>t

The total clearing I<sup>2</sup>t at rated voltage and at power factor of 15% are given in the electrical characteristics. For other voltages, the clearing I<sup>2</sup>t is found by multiplying by correction factor, K, given as a function of applied working voltage, E<sub>g</sub>, (RMS).

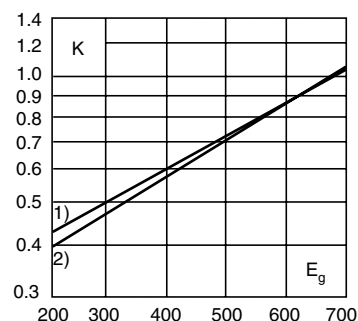

1) 5-30 Amp Range  
2) 32-50 Amp Range

### Arc Voltage

This curve gives the peak arc voltage, U<sub>L</sub>, which may appear across the fuse during its operation as a function of the applied working voltage, E<sub>g</sub>, (RMS) at a power factor of 15%.

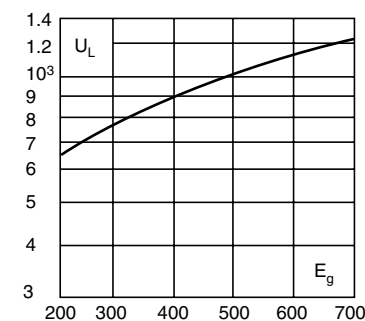

### Power Losses

Watts loss at rated current is given in the electrical characteristics. The curve allows the calculation of the power losses at load currents lower than the rated current. The correction factor, K<sub>p</sub>, is given as a function of the RMS load current, I<sub>b</sub>, in % of the rated current.

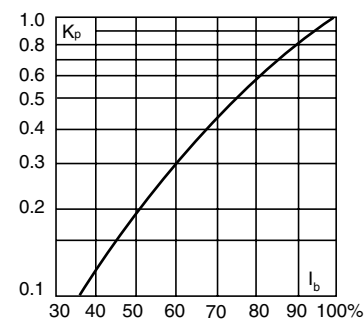

BIF document: 720025



For complete specification data, visit our Web site at [www.bussmann.com](http://www.bussmann.com)  
or call Bussmann Information Fax ~ 636.527.1450



# Ferrule FWP 660V/700V (IEC/U.L.) 20-100A



Electrical Characteristics				Ordering Information			Dimensions	Curves	
Size	Rated Current RMS-Amps	I <sup>2</sup> t (A <sup>2</sup> S)		Watts Loss	Part Number	Carton Qty.	Carton Weight (kg)	Figure Number	See Page
		Pre-arc	Clearing at 660V						
22 x 58mm (7/8")	20	23	260	4.6	FWP-20A22F	10	0.450	Fig. 1	page 107
	25	37	410	5.6	FWP-25A22F				
	32	55	605	7.0	FWP-32A22F				
	40	68	750	8.5	FWP-40A22F				
	50	155	1600	9.5	FWP-50A22F				
	63	280	3080	11	FWP-63A22F				
	80	600	6600	13.5	FWP-80A22F				
	100	1100	12500	16	FWP-100A22F				

- Interrupting rating 200kA RMS Symmetrical.
- Watts loss provided at rated current.
- (500 Vdc/Interrupting rating 50kA) U.L. Recognition.
- See accessories on page 102.

1 kg = 2.2 lbs. 1 lb = 0.45 kg

## Dimensions

Fig. 1: 20-100 Amp Range

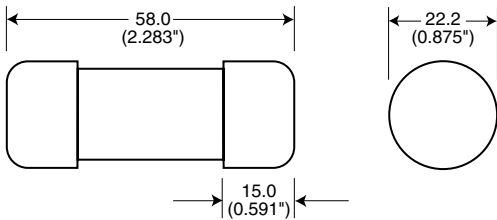

Dimension in mm.  
1mm = 0.0394" 1" = 25.4mm

## Electrical Characteristics

### Total Clearing I<sup>2</sup>t

The total clearing I<sup>2</sup>t at rated voltage and at power factor of 15% are given in the electrical characteristics. For other voltages, the clearing I<sup>2</sup>t is found by multiplying by correction factor, K, given as a function of applied working voltage, E<sub>g</sub>, (RMS).

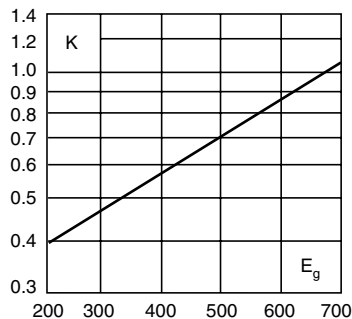

### Arc Voltage

This curve gives the peak arc voltage, U<sub>L</sub>, which may appear across the fuse during its operation as a function of the applied working voltage, E<sub>g</sub>, (RMS) at a power factor of 15%.

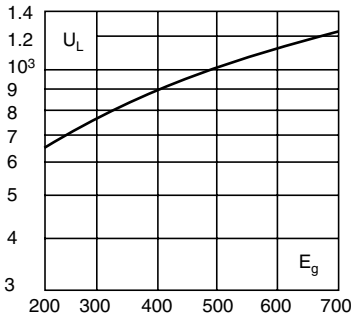

### Power Losses

Watts loss at rated current is given in the electrical characteristics. The curve allows the calculation of the power losses at load currents lower than the rated current. The correction factor, K<sub>p</sub>, is given as a function of the RMS load current, I<sub>b</sub>, in % of the rated current.

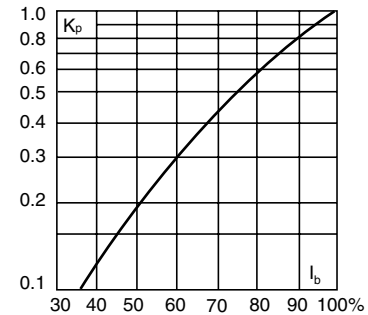



# Ferrule FWK 750V 5-60A

Electrical Characteristics				Ordering Information				Dimensions	Curves
Size	Rated Current RMS-Amps	I <sup>2</sup> t (A <sup>2</sup> S)		Watts Loss	Part Number	Carton Qty.	Carton Weight (kg)	Figure Number	See Page
		Pre-arc	Clearing at 750 Vdc						
20 × 127mm (1 <sup>3</sup> / <sub>16</sub> "	5	8.5	16	—	FWK-5A20F	10	0.95	Fig. 1	page 107
	8	50	100	—	FWK-8A20F				
	10	95	200	—	FWK-10A20F				
	15	100	240	—	FWK-15A20F				
	20	125	315	—	FWK-20A20F				
	25	400	1100	—	FWK-25A20F				
25 × 146mm (1"	30	800	2600	—	FWK-30A20F	10	1.65	Fig. 2	
	35	1300	4300	—	FWK-35A25F				
	40	1600	5300	—	FWK-40A25F				
	50	3100	12000	—	FWK-50A25F				
	60	5900	24000	—	FWK-60A25F				

- Interrupting rating 45kA RMS symmetrical.
- 750 Vdc rating for 5 through 60 amperes (Time constant = 10-15 ms).
- See accessories on page 102.

1 kg = 2.2 lbs. 1 lb = 0.45 kg

## Dimensions

Fig. 1: 5-30 Amp Range

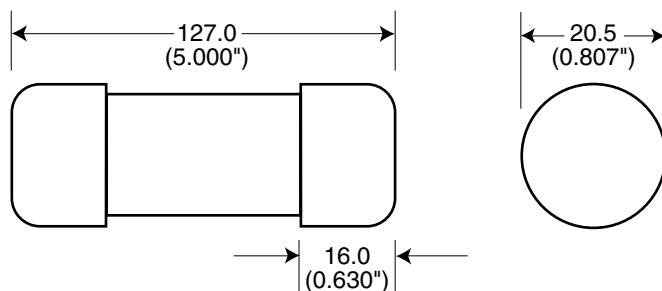
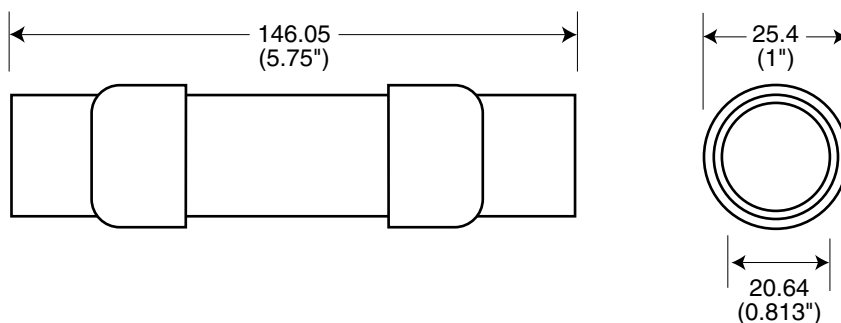

Fig. 2: 35-60 Amp Range



Dimension in mm.  
1mm = 0.0394" 1" = 25.4mm







# Ferrule FWJ 1000V 20-30A



Electrical Characteristics				Ordering Information				Dimensions	Curves
Size	Rated Current RMS-Amps	I <sup>2</sup> t (A <sup>2</sup> S)		Watts Loss	Part Number	Carton Qty.	Carton Weight (kg)	Figure Number	See Page
		Pre-arc	Clearing at 1000V						
14 × 67mm ( <sup>9</sup> / <sub>16</sub> "	20	25	220	9	FWJ-20A14F	10	0.300	Fig. 1	page 108
	25	33	350	11	FWJ-25A14F				
	30	52	450	14	FWJ-30A14F				

- Interrupting rating 25kA RMS Symmetrical.
- Watts loss provided at rated current.
- (800 Vdc/Interrupting rating 20kA) U.L. Recognized.
- See accessories on page 102.

1 kg = 2.2 lbs. 1 lb = 0.45 kg

## Dimensions

Fig. 1: 20-30 Amp Range

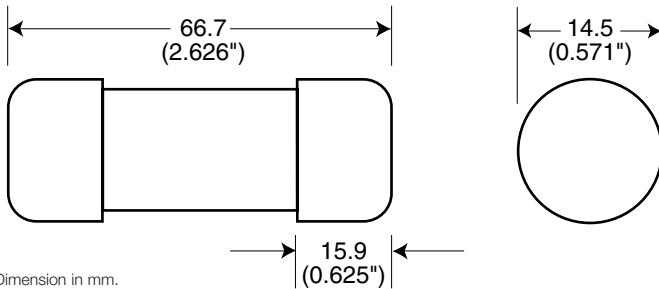

Dimension in mm.  
1mm = 0.0394" 1" = 25.4mm

## Electrical Characteristics

### Total Clearing I<sup>2</sup>t

The total clearing I<sup>2</sup>t at rated voltage and at power factor of 15% are given in the electrical characteristics. For other voltages, the clearing I<sup>2</sup>t is found by multiplying by correction factor, K, given as a function of applied working voltage, E<sub>g</sub>, (RMS).

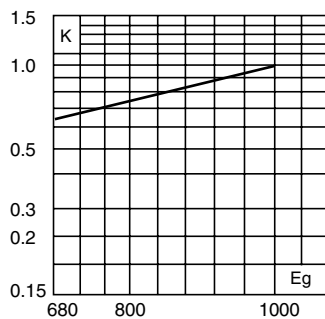

### Arc Voltage

This curve gives the peak arc voltage, U<sub>L</sub>, which may appear across the fuse during its operation as a function of the applied working voltage, E<sub>g</sub>, (RMS) at a power factor of 15%.

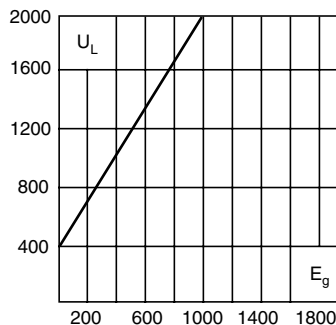

### Power Losses

Watts loss at rated current is given in the electrical characteristics. The curve allows the calculation of the power losses at load currents lower than the rated current. The correction factor, K<sub>p</sub>, is given as a function of the RMS load current, I<sub>b</sub>, in % of the rated current.

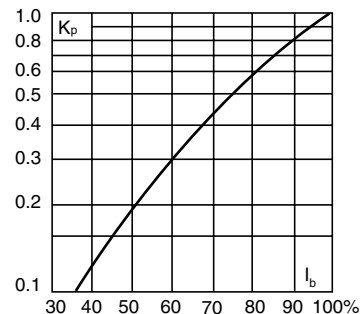



**Ferrule**

**FWL/FWS 1250V/1500V/2000V 2-30A**

Size	Electrical Characteristics			Ordering Information				Dimensions	Curves
	Rated Current RMS-Amps	I <sup>2</sup> t (A <sup>2</sup> S)		Watts Loss	Part Number	Carton Qty.	Carton Weight (kg)	Figure Number	See Page
		Pre-arc	Clearing at 1000 Vdc						
20 × 127mm ( <sup>13</sup> / <sub>16</sub> " <sup>n</sup> )	¥2	0.8	2.4	4.4	FWS-2A20F	10	1.00	Fig. 1	page 108
	¥6	27	81	6.7	FWS-6A20F				
	†8	64	192	7.6	FWS-8A20F				
	†10	118	277	3.0	FWS-10A20F				
	†12	170	380	3.4	FWS-12A20F				
	†15	209	500	5.0	FWS-15A20F				
	‡20	675	1550	5.9	FWL-20A20F				
	‡25	1200	2760	6.5	FWL-25A20F				
	‡30	1850	4300	7.5	FWL-30A20F				

- Interrupting rating 45kA RMS Symmetrical.
- Rated voltage (IEC) ¥ 2000V †1500V ‡1250V
- 1000 Vdc/30kA rating.
- See accessories on page 102.

1 kg = 2.2 lbs. 1 lb = 0.45 kg

**Dimensions**

Fig. 1: 2-30 Amp Range

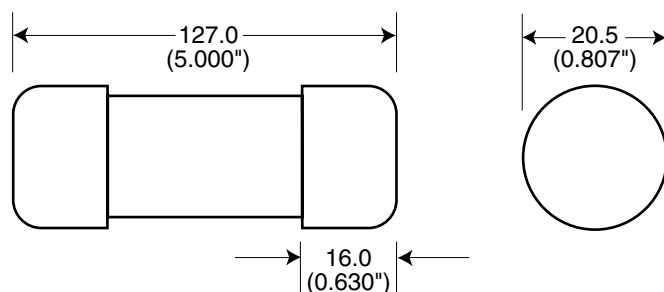

Dimension in mm.  
1mm = 0.0394" 1" = 25.4mm





## Ferrule - Accessories Fuseholders



**Catalog Symbol:** CH Series

**Features:**

- 10 x 38 Dovetail design provides maximum flexibility in assembling multiple poles
- Touchsafe design - No exposed contacts
- DIN rail mount (35mm)
- Optional open fuse indication lights
- Excellent for switchboard panel, control consoles, small motors, transformers, and similar applications
- Handle/fusepuller to install and remove fuses easily
- Available in single and multi-pole configurations
- Circuit marking system (P/N CH10CL and CH10CM)
- Wire ready: Saves time as terminals are ready to accept wires.
- CE marking

**Standards:**

**North American 10 x 38 Class CC**

Listed U.L. 512, Guide IZLT, File E14853  
 Certified CSA Std. C22.2 No. 39, Class 6225 01,  
 File 47235

**North American 10 x 38 Midget**

Recognized U.L. 512, Guide IZLT2, File E14853  
 Certified CSA Std. C22.2 No. 39, Class 6225 01,  
 File 47235

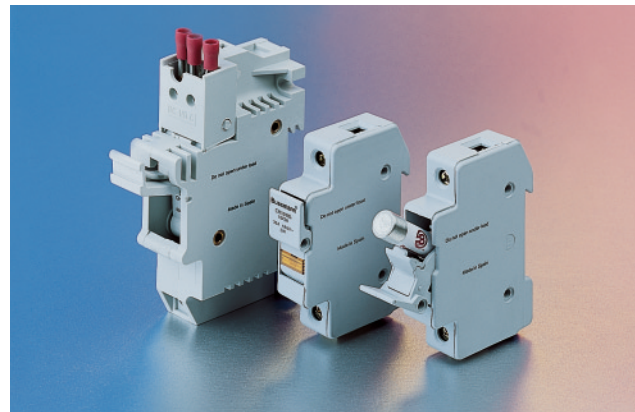

**European 10 x 38** IEC 269-2-1  
**14 x 51** IEC 269-2  
**22 x 58** IEC 269-2

**Recommended Buss® Fuse Types:**

- 10 x 38 North American Class CC Fuses - LP-CC, FNQ-R, KTK-R
- 10 x 38 North American Midget Fuses - FNQ, KTK, AGU, BAF, BAN, FNM, FWA, & FWC
- 14 x 51 Fuses - FWX, FWH, FWP & NON
- 22 x 58 Fuses - FWP

**BIF document: 1151**

**Catalog Symbol:** J70100

**Ampere Rating:** 100 Amperes

**Voltage Rating:** 700 Volts AC

**Agency Approvals:**

UL Recognized, Guide IZLT2, File E14853

**Withstand Rating:** 200,000 RMS Sym. Amps

For use with 22 x 58mm fuses  
 (FWP-40A22F, FWP-100A22F, etc.)

**Materials:** Thermoplastic

**UL Flammability:** 94 VO

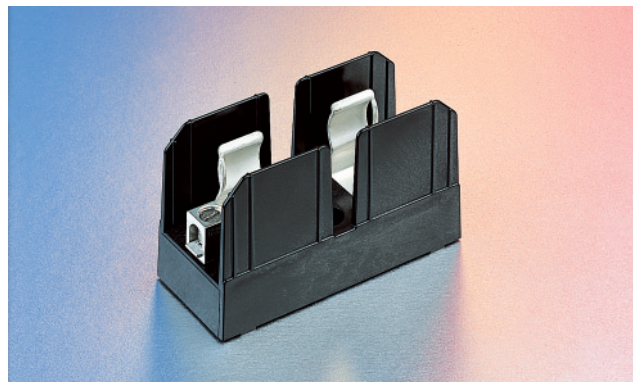

Amps	Poles	Catalog Numbers	
		Box Lug w/ Retaining Clip	Max. Wire Size
100	1	J70100-1CR	#2
	2	J70100-2CR	#2
	3	J70100-3CR	#2

**BIF document: 1211**





# Ferrule Curves

## FWA 150V 5-30A (10 × 38mm) Time-Current Curve

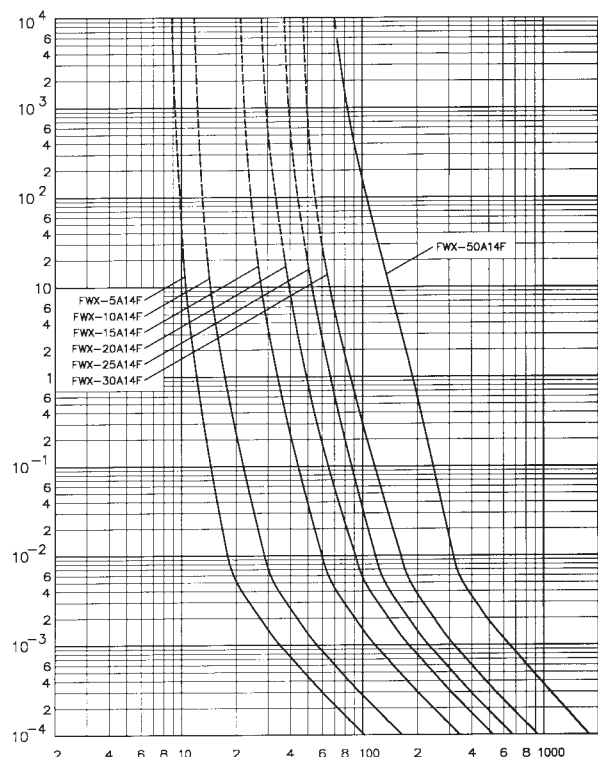

## FWA 150V 35-60A (21 × 51mm) Time-Current Curve

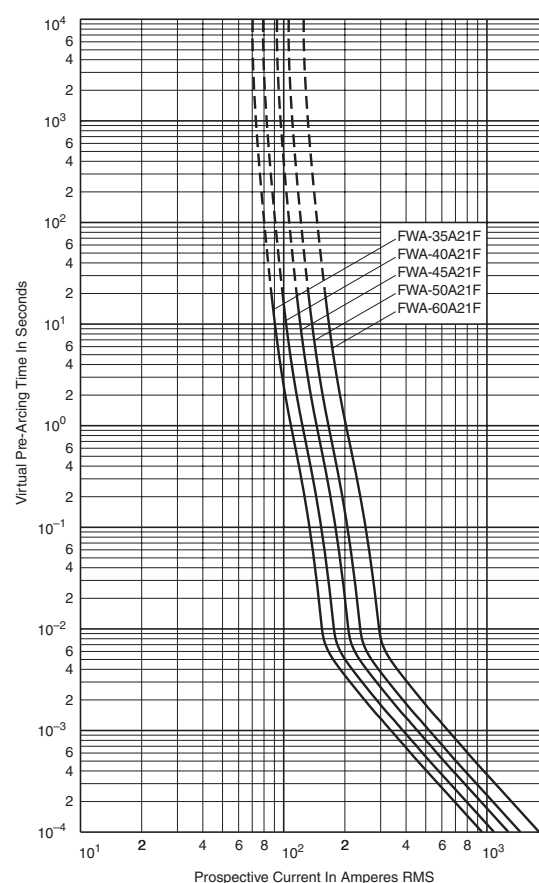

## Peak Let-Through Curve

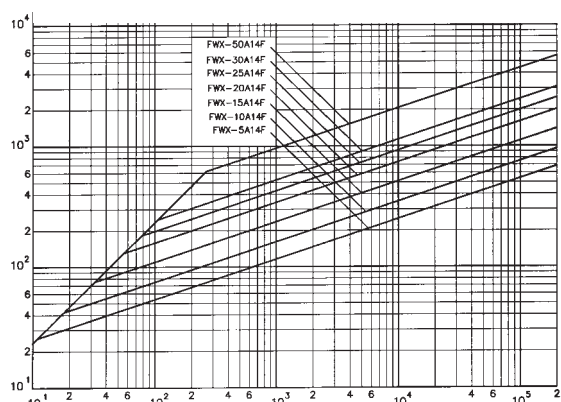

## Peak Let-Through Curve

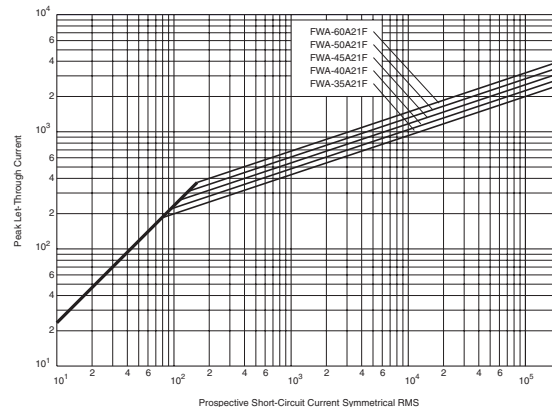

BIF document: 35785317

BIF document: 35785305



For complete specification data, visit our Web site at [www.bussmann.com](http://www.bussmann.com)  
or call Bussmann Information Fax ~ 636.527.1450



# Ferrule Curves

## FWX 250V 1-30A (14 × 51mm) Time-Current Curve

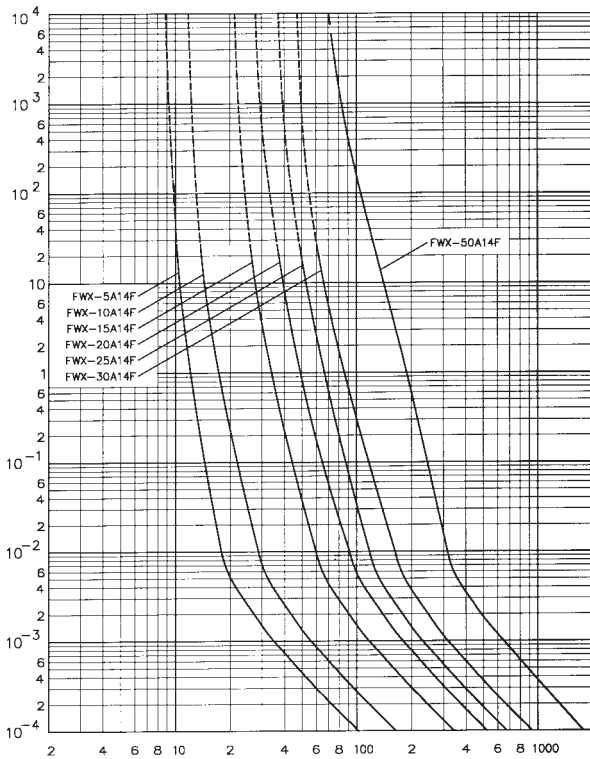

## FWH 500V 0.25-7A (6 × 32mm) Time-Current Curve

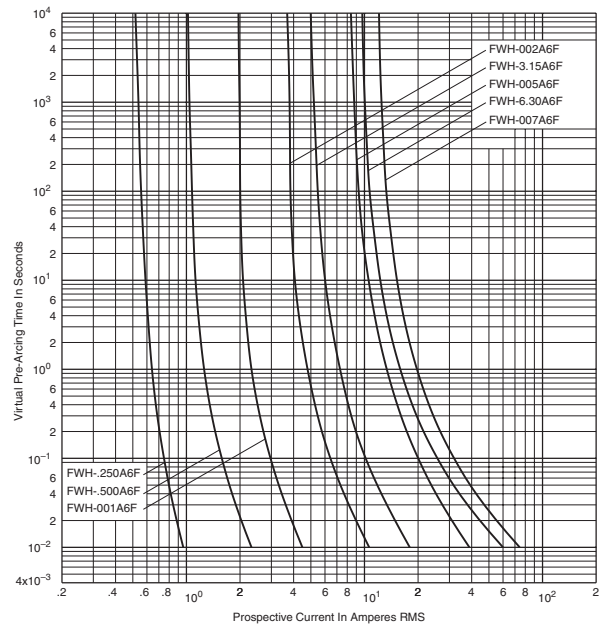

## Peak Let-Through Curve

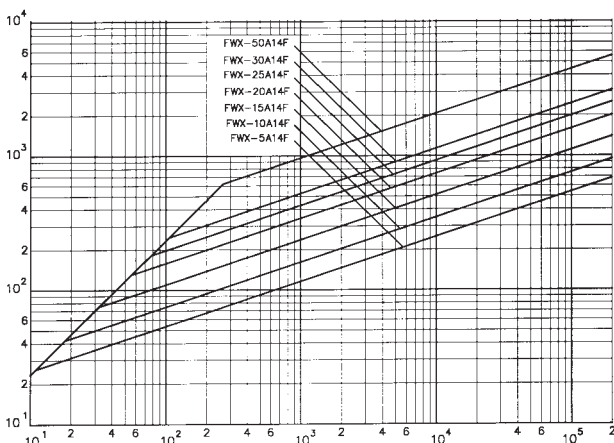

BIF document: 35785302

BIF document: 35785256





# Ferrule Curves

## FWH 500V 10-30A (6 × 32mm) Time-Current Curve

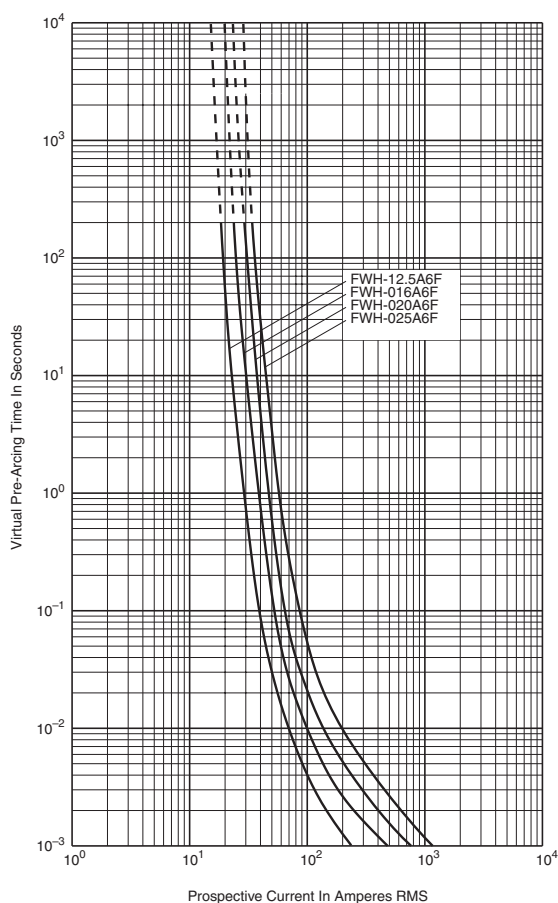

## FWH 500V 1-30A (14 × 51mm) Time-Current Curve

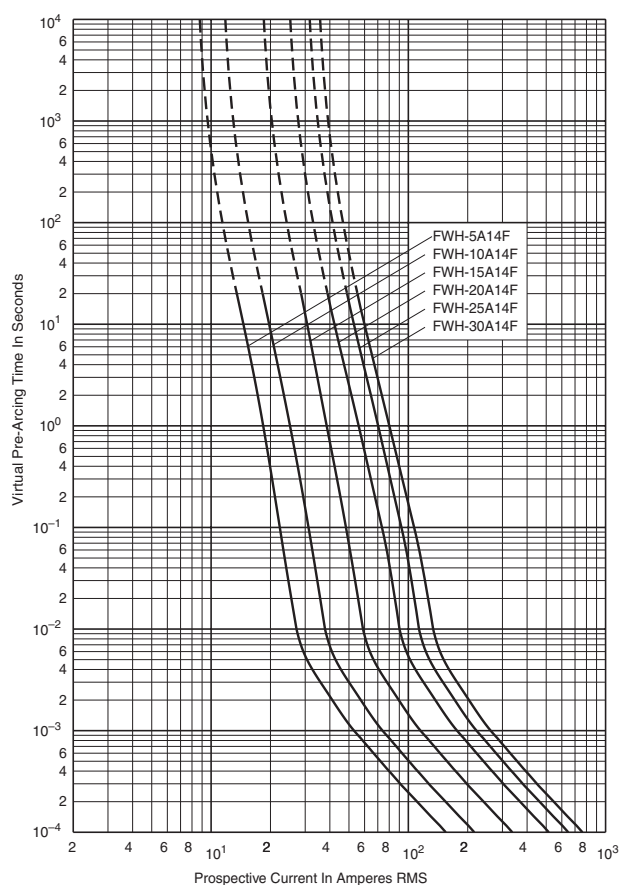

## Peak Let-Through Curve

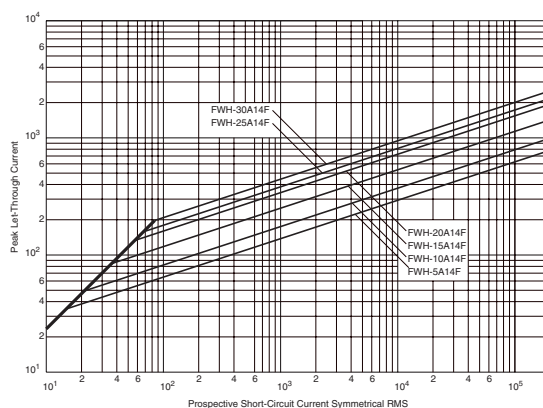

BIF document: 50955

BIF document: 35785298



For complete specification data, visit our Web site at [www.bussmann.com](http://www.bussmann.com)  
or call Bussmann Information Fax ~ 636.527.1450



# Ferrule Curves

## FWC 600V 6-32A (10 × 38mm) Time-Current Curve

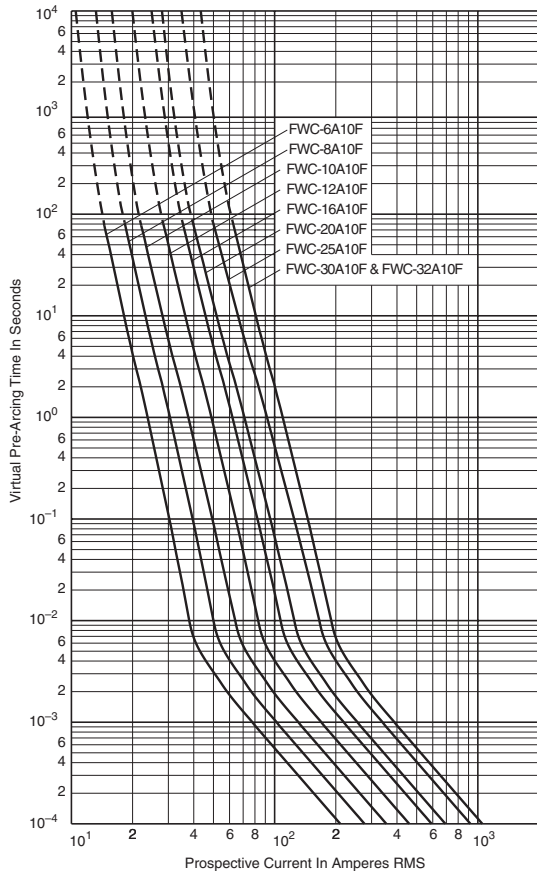

### Peak Let-Through Curve

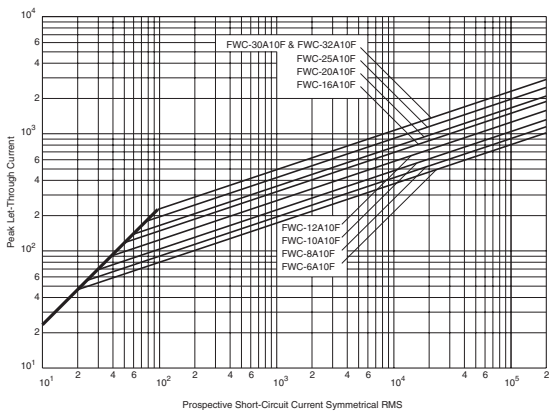

BIF document: 35785306

## FWP 660V/700V 1-50A (14 × 51mm) Time-Current Curve

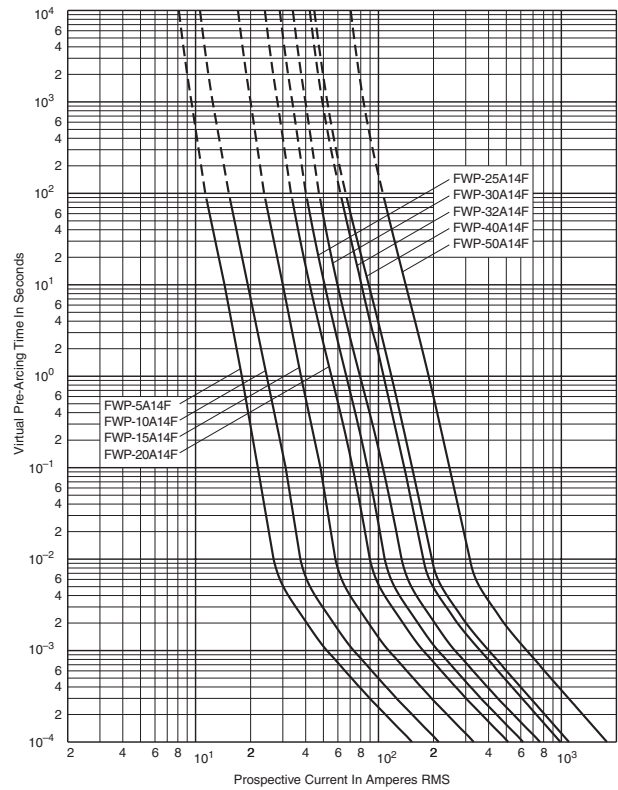

### Peak Let-Through Curve

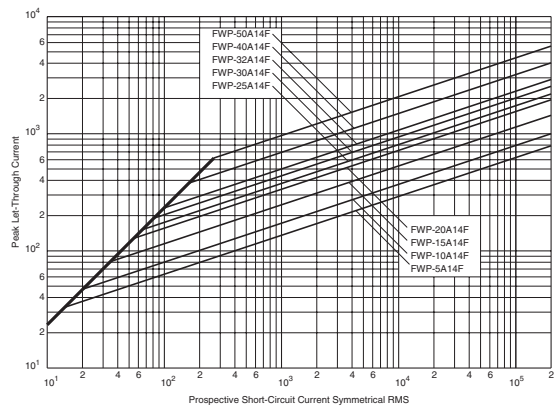

BIF document: 35785307







## Ferrule Curves

### FWP 660V/700V 20-100A (22 x 58mm) Time-Current Curve

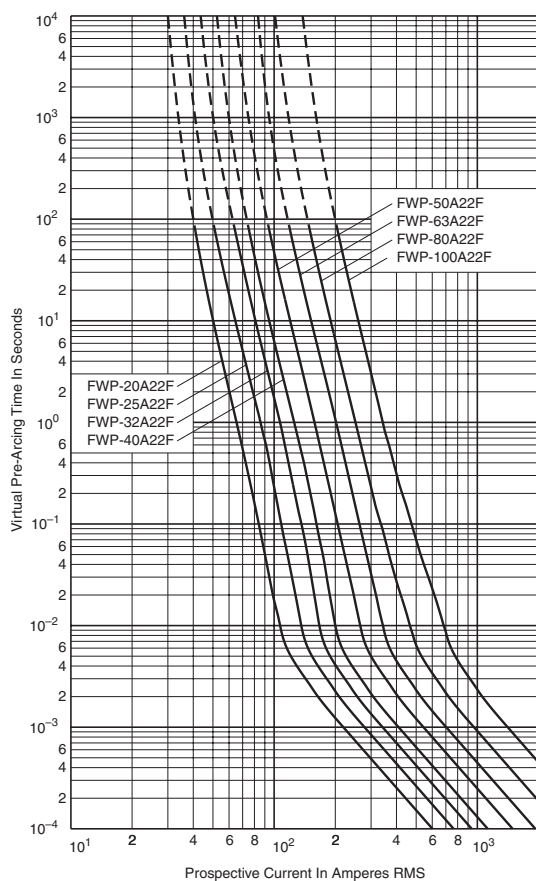

### Peak Let-Through Curve

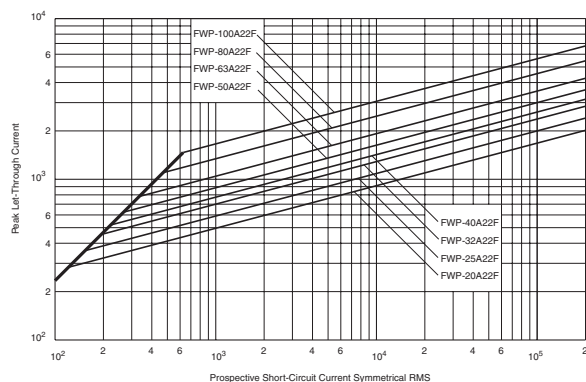

### FWK 750V 5-30A (20 x 127mm) FWK 750V 35-60A (25 x 146mm) Time-Current Curve

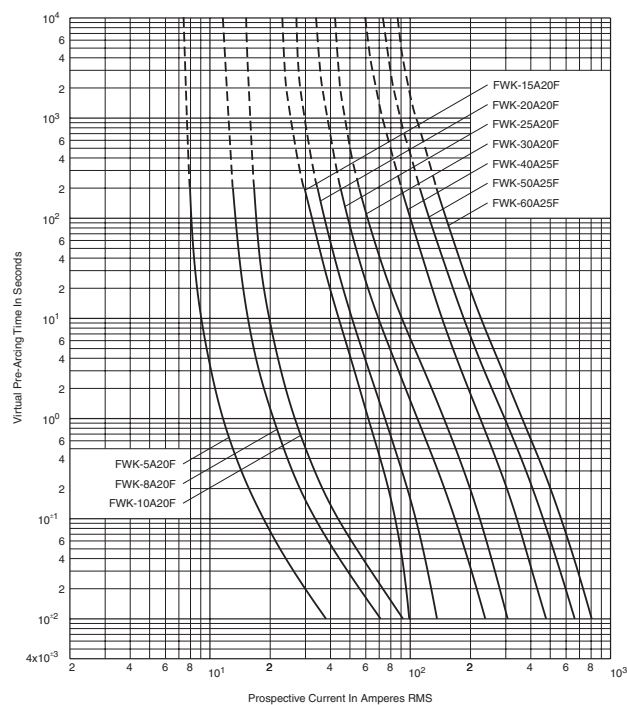





## Ferrule Curves

### FWJ 1000V 20-30A (14 × 67mm) Time-Current Curve

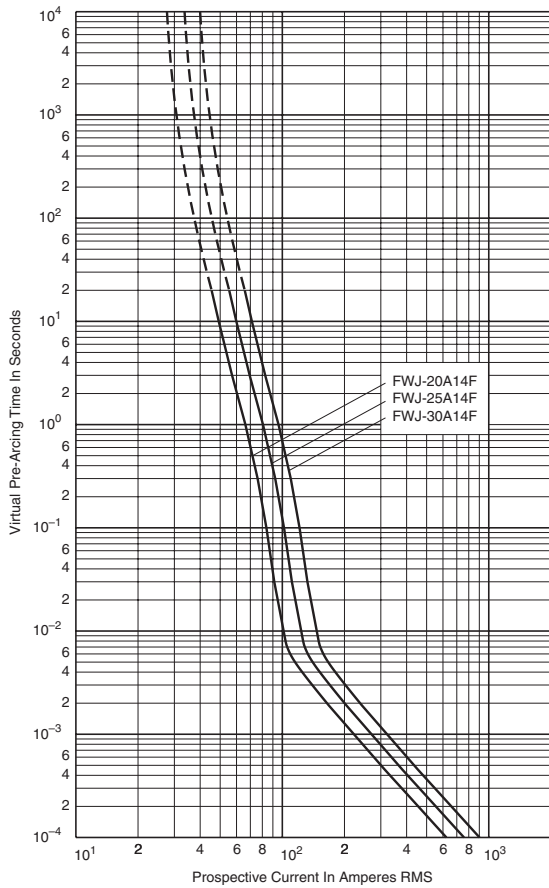

### Peak Let-Through Curve

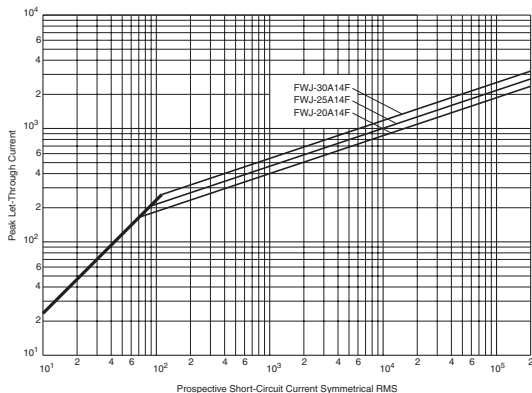

BIF document: 35785315

### FWL/FWS 1250V/1500V 2-30A (20 × 127mm) Time-Current Curve

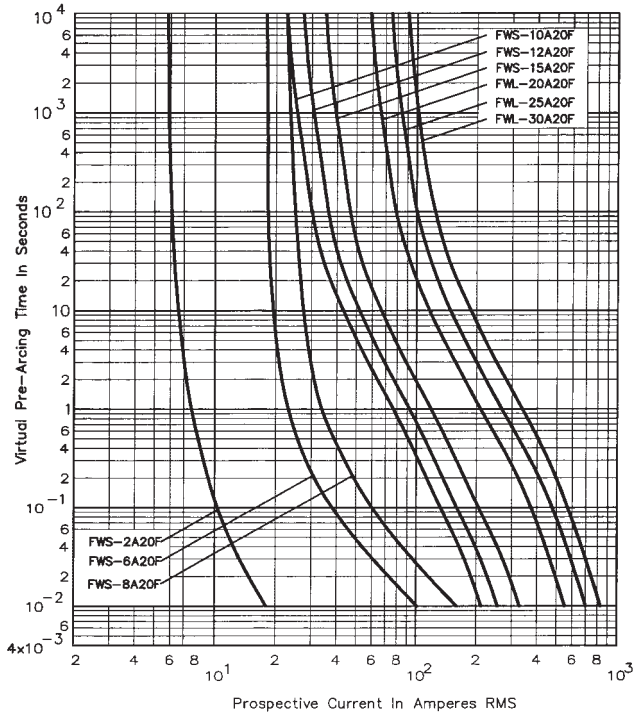

BIF document: 35785109

